

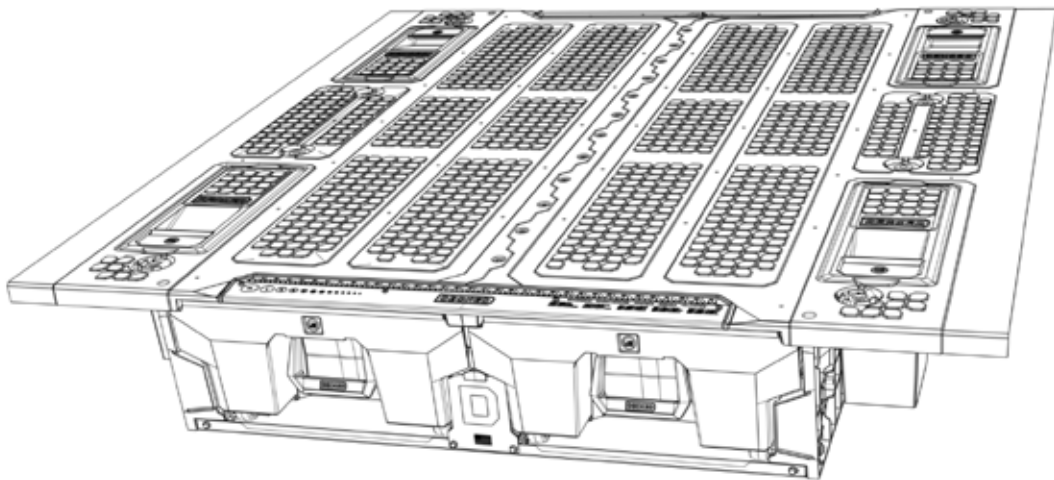

# INSTALLATION INSTRUCTIONS\*



## XS3 FORD SUPER DUTY 6'9" 2017 - CURRENT

\*Trust us on this one; don't go commando and attempt your install without reading. You'll just cuss a bunch and create even more chaos in your truck bed.

# TOOLS REQUIRED

---

- Phillips head screwdriver x 2
- 7/16" wrench
- 3/8" socket
- 3/16" and 7/32" hex keys  
(we included these for you, but you may prefer your own)
- Trusted friend with a weak mind and a strong back.

# INSTALL VIDEO

---

High tech link to video here or you can visit [decked.com/video](https://decked.com/video)



# HEY! TORQUE BOY

## READ BEFORE YOU INSTALL

---

Welcome to DECKED! In a world of crappy instructions, bad advice, and questionable sources of truth, we are here to make sure that your install goes as smoothly as possible, saving you headaches and heartburn. That said, your part is to read the darned instructions!

1. Only use cordless screw guns or drivers with a clutch and speed setting adjustment.
2. Set your clutch down in the bottom 1/3 of the available torque settings.
3. Set your drill speed to the slowest speed.
4. We tell you all of this to prevent you from blowing up the inserts and setting your install back. Start screws into inserts with your fingers to make sure you don't cross-thread.
5. Do NOT use pneumatic air tools or old school tools with no torque settings.

\*NOTE: Two extra threaded inserts are included in the PREP-EXTRA bag. That's all you get big timer, unless you call us and ask for more. The repair inserts will replace any stripped inserts in the corner support feet and the vert. So, hand-tighten until snug only! You can also screw the feet inserts back in if dislocated. Use a flat screwdriver to screw them back in from below.

# CONTENTS

---

## DECKED CARTON

LEFT C-CHANNEL ASSEMBLY .....	1
RIGHT C-CHANNEL ASSEMBLY .....	1
LEFT/DRIVER PANEL .....	1
RIGHT/PASSENGER PANEL.....	1
CABSIDE CLOSEOUT .....	1
CENTER VERT (AXLE INSTALLED) .....	1
DRAWERS (ONE HANDLE INSTALLED) .....	2
STASH BIN LIDS.....	4
STASH BIN/DEEP .....	2
STASH BIN/SHALLOW .....	2
TORSION BRACE.....	1
RULER .....	1
HARDWARE KIT .....	1
SIXER CASE .....	1
HALFRACK CASE.....	1
DRAWER DIVIDERS .....	2
DRAWERGANIZER .....	1

## HARDWARE BOX

PREP EXTRA  
BOLTS  
NUTS AND BOLTS  
D-RINGS  
FS-D-RINGS HW  
DRAWER BRACKETS  
DRAWER HW  
TUBES  
BARREL NUTS/SCREWS  
HANDLE  
HANDLE HARDWARE  
XY WHEELS x 2 bags  
FS SCREWS  
PLUGS  
CODPIECE  
WEATHERSTRIPS  
3/16" HEX KEY  
7/32" HEX KEY  
TURNBUCKLES  
BARREL NUTS/SCREWS - LONG DRAWERS ONLY (6'4" - 8' beds: Bag included in outer carton)

# ASSEMBLY OVERVIEW

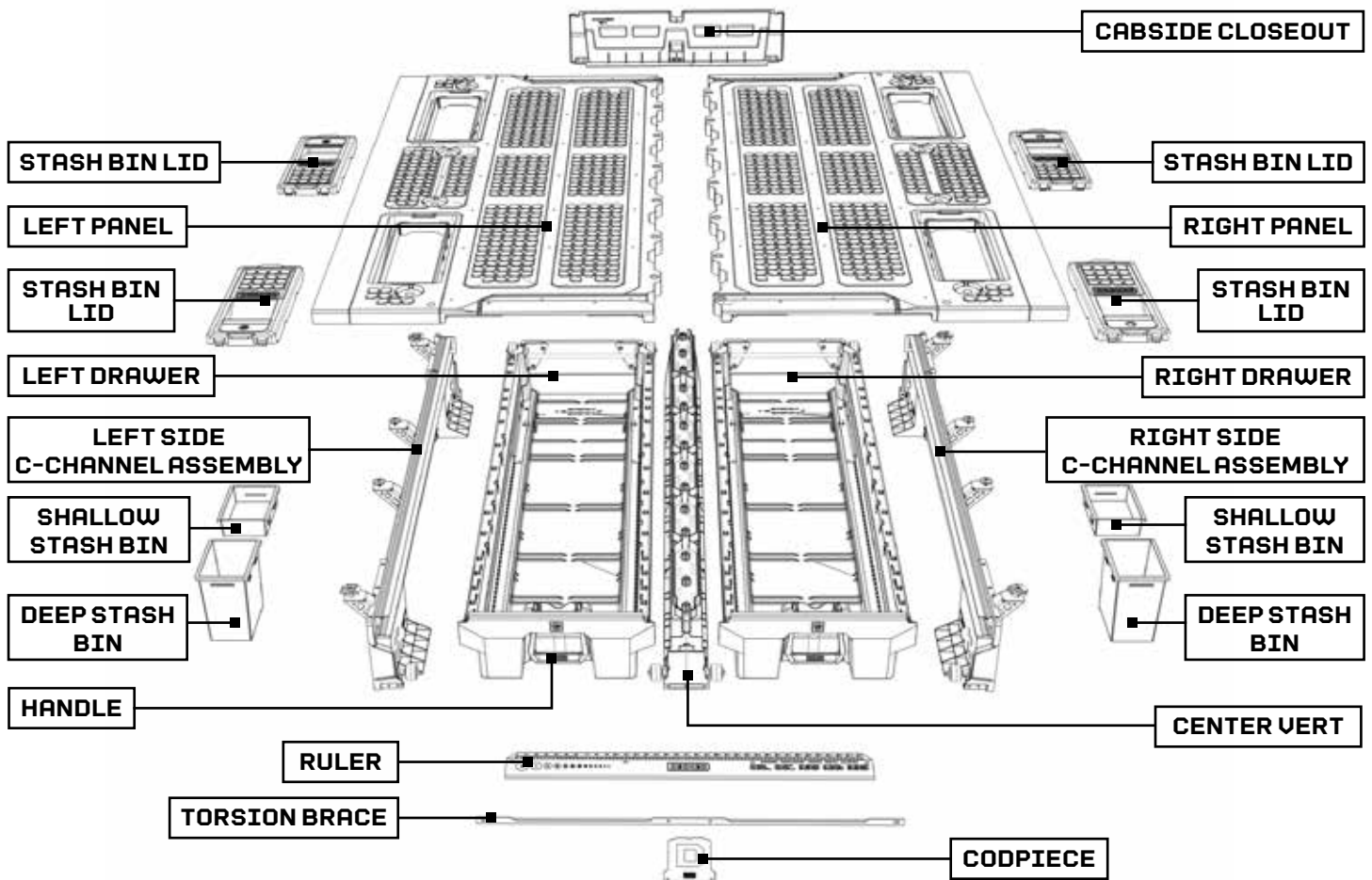

## ARE YOU ADDING A CARGOGLIDE TO YOUR DRAWER SYSTEM?

1. You will need CargoGlide Mounting Brackets. If you do not have these, they are available on our website.
2. The brackets and CargoGlide can be added after installing the Drawer System into your truck bed.

# STEP 1:

# ARRANGE YOUR ARRANGEMENT

---

1. On flat ground arrange the two side assemblies and center vert as shown.
2. All three axles must be located at the tailgate end of your lay out.
3. Use the 1" bolts in the NUTS AND BOLTS bag. These may be black or zinc. Install two 1" bolts through the horizontal slotted holes in the C-Channel just inbound from the cabside and tailgate installed tie downs where shown. Install a flanged nut on the outside of the C-Channel. The slotted holes may be on the top or bottom of the C-Channel, depending on the side.
4. Tighten all C-Channel bolts and nuts except for the three on the tailgate end. Leave these loose for now. Make sure the tie downs are plumb and level with the tops of the C-Channels.

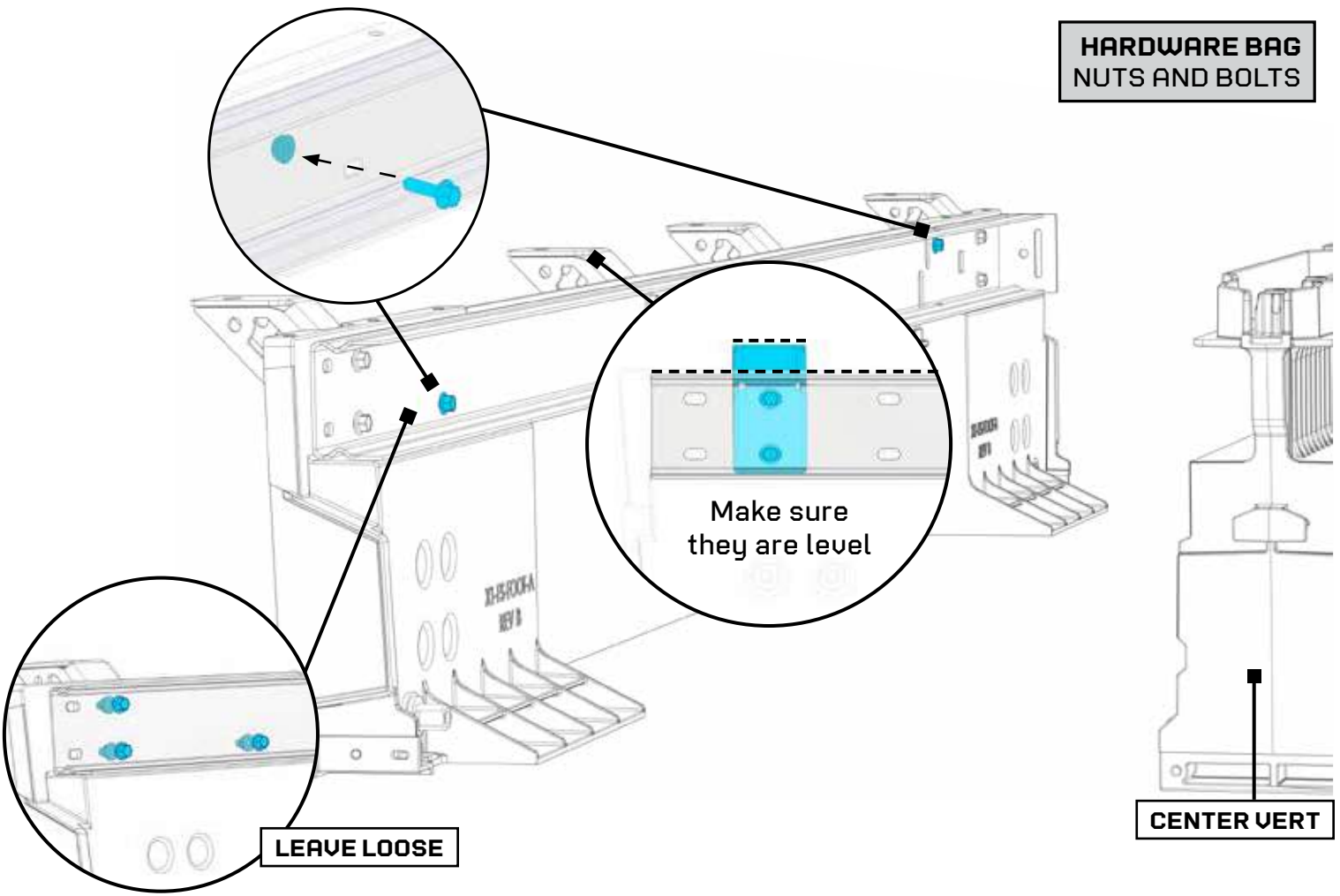
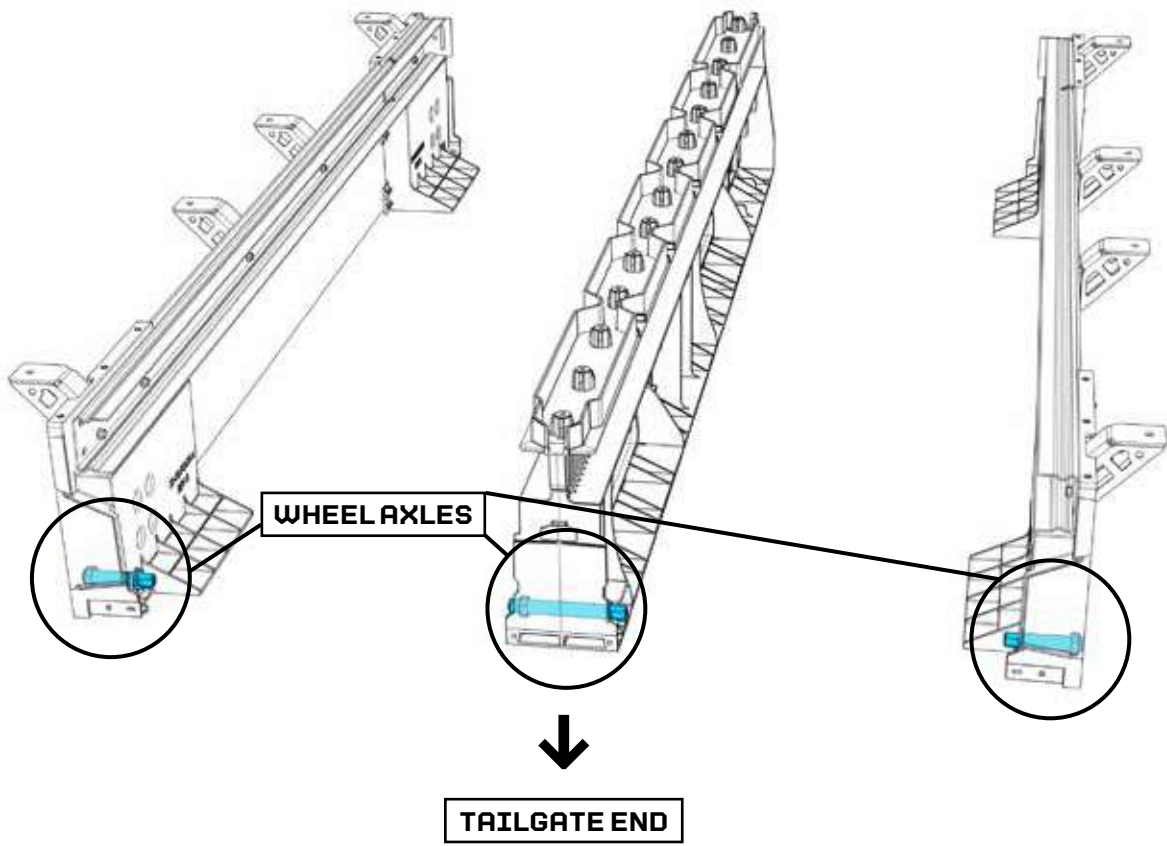

# STEP 2:

# ARRANGE YOUR ARRANGEMENT

---

1. The panel label must be on the tailgate end.
2. While supporting the C-Channel assembly, place the left side panel on top of the assembly, seating the panel on the vert bosses.
3. Shift the tailgate feet to align the threaded inserts in the corner feet to the mounting holes in the deck panels.
4. Once all mounting positions are aligned, use three BOLTS to fasten the panel to the cabside corner foot. Tighten just until snug. Repeat with the tailgate foot.
5. DO NOT attach the panel to the center vert yet!
6. Place the right side panel on the assembly and repeat the above steps.
7. Tighten the three C-channel bolts and nuts on each tailgate foot.
8. Stretch your hamstrings.



**HARDWARE BAG  
BOLTS**

**LEFT SIDE PANEL**

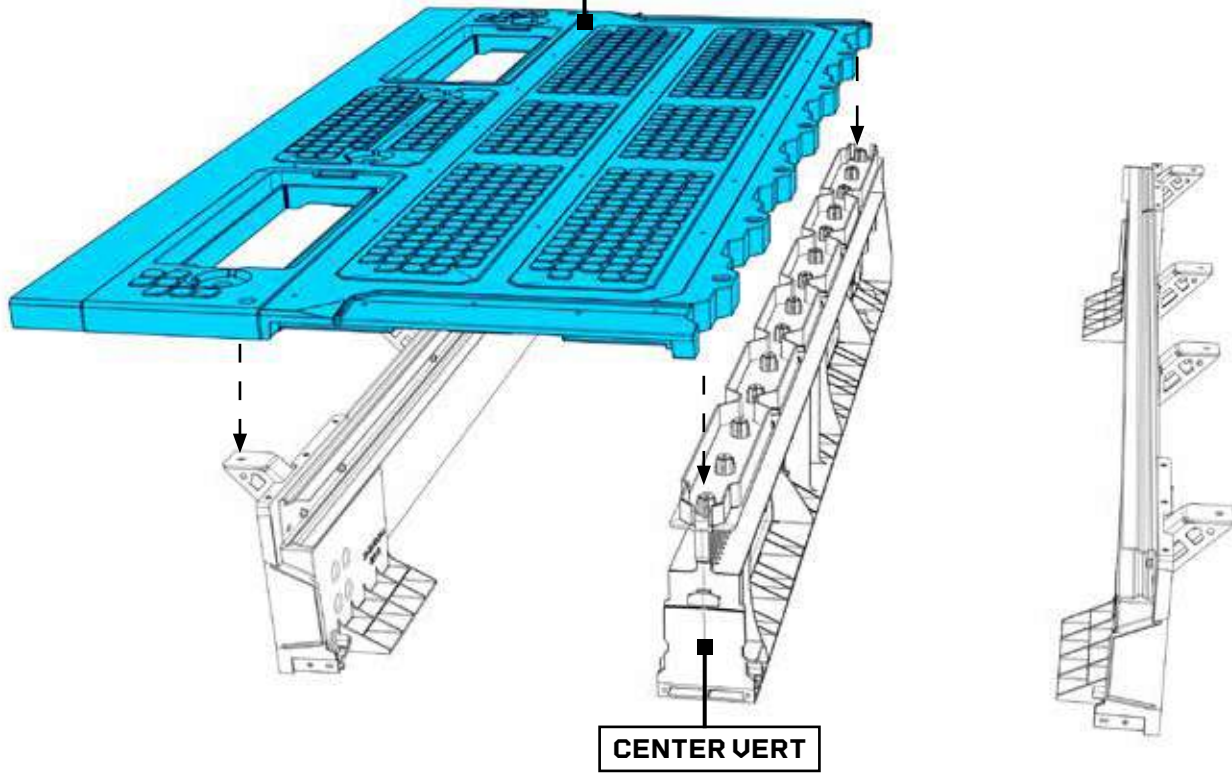

**CENTER VERT**

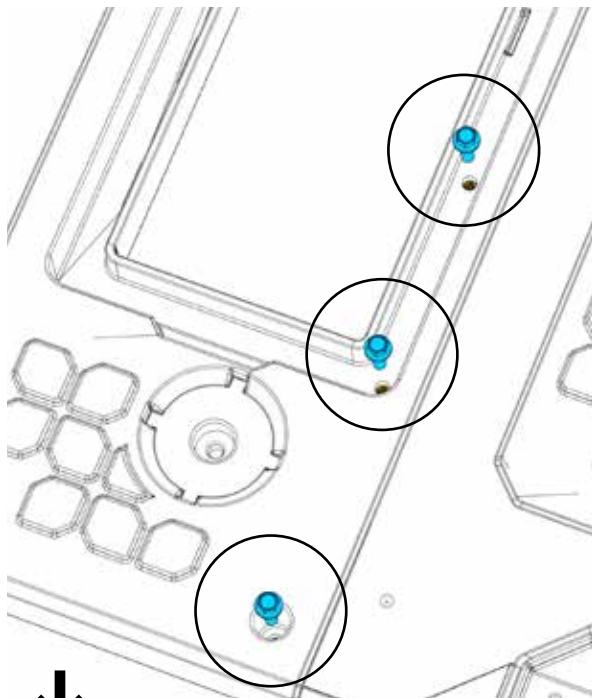

**TAILGATE END**

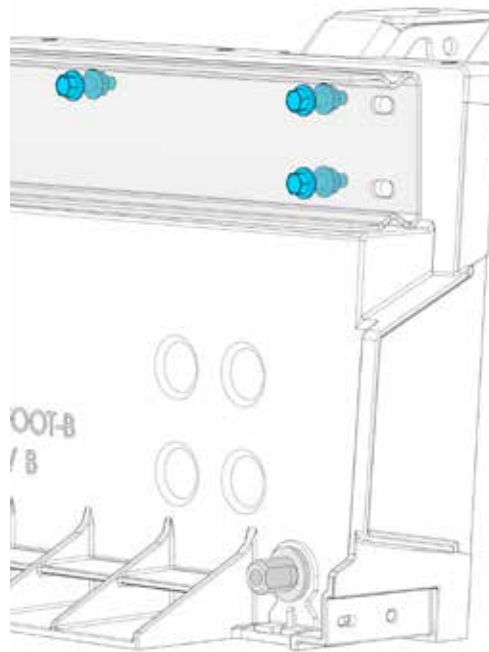

**TAILGATE  
END**

Tighten the three C-channel  
bolts and nuts

# STEP 3: RING IN THE NEW YOU!

---

1. D-Rings may be installed in any of the eight locations depending on your liking. Most sane people use the four corners. You can purchase additional D-Rings on our website.
2. Install D-Ring flat side down on top of silver spacer. Then place small black washer on top of D-ring and fasten with bolt. Tighten fully with a 3/16" hex wrench (included in your hardware kit).
3. In the unused tie down locations, install the large black washers and bolts in the two center depressions.
4. Repeat all steps for the other panel.
5. Do not install into the truck bed yet.

**HARDWARE BAG**  
D-RINGS, FS D-RINGS HW

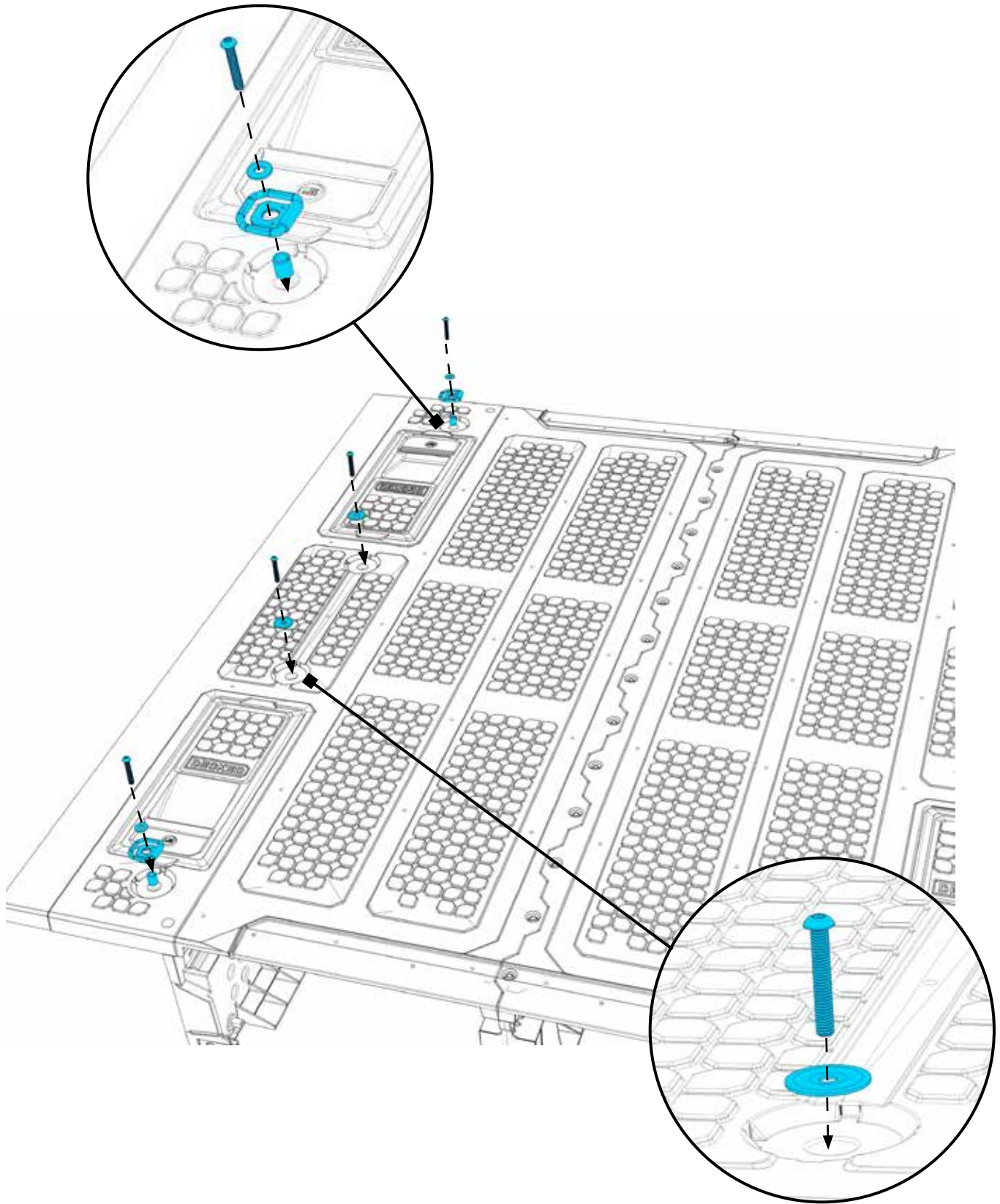

# STEP 4:

# ADORN YOUR DRAWERS

---

1. **LONG BED TRUCKS ONLY: (6'4" - 8' beds)**  
Your drawers will have drawer braces pre-installed.  
Look for the **BARREL NUTS/SCREWS** bag in the outer carton, not in your hardware kit.

Install two barrel nuts/screws through each drawer brace where shown.

There are no drawer brackets in the short drawers (5'5" - 5'9" beds) - skip this step.

2. Each drawer has a left and a right wheel bracket.
3. Place the brackets into the drawers as shown.
4. Install two 3/4" bolts into the bottom two bracket holes. Secure with nuts and tighten until snug.
5. Install the 1.5" (the obviously longer one) bolt into the back mounting hole where shown. Secure with a nut and tighten until snug.
6. Use two 3/4" bolts to install the tube braces.
7. Install the **BIG** wheels with a 7/32" hex driver.
8. Flex for the neighbors.

**HARDWARE BAG**  
DRAWER BRACKETS, DRAWER HW, XY WHEELS,  
TUBES, BARREL NUTS/SCREWS (long drawers only)



**BARREL SCREWS INSTALLED  
INTO DRAWER BRACKETS.  
LONG BEDS ONLY.**

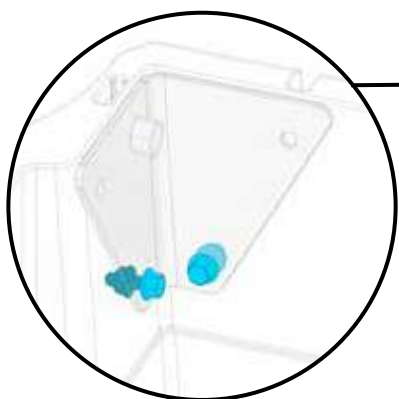
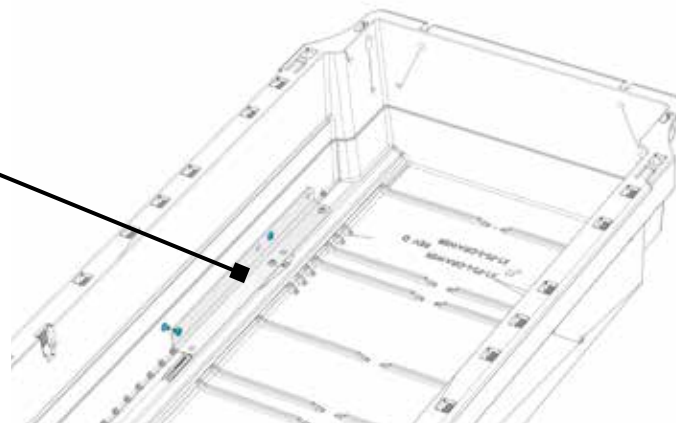

**3/4" BOLTS**

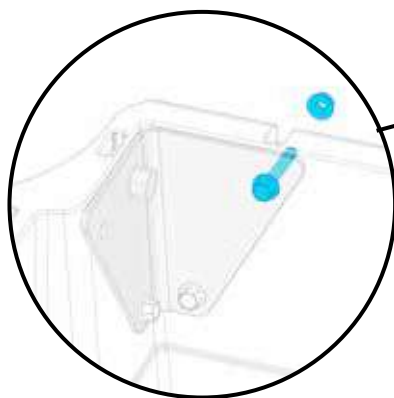

**1.5" BOLT**

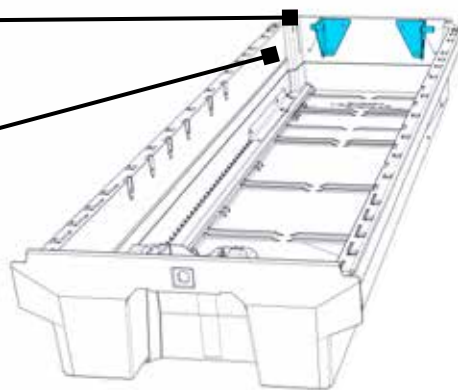

**TUBE BRACE**

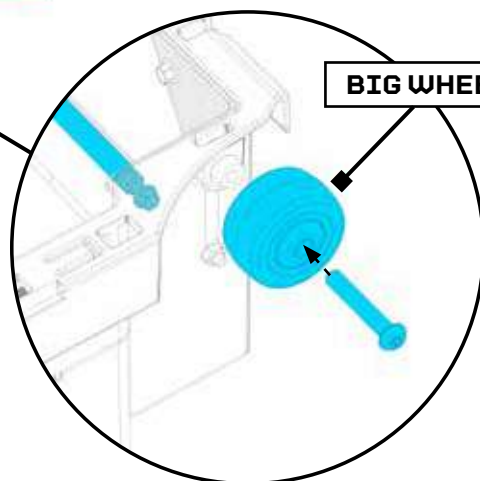
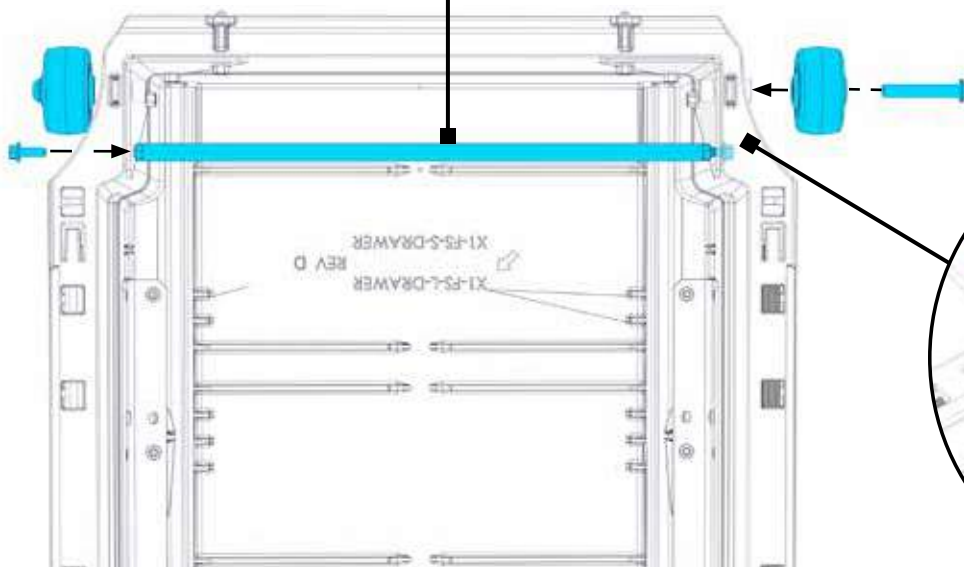

**BIG WHEEL**

# STEP 5:

# THE LOVE HANDLE

---

1. Ok, big timer, one drawer handle assembly needs to be done by you. Why? We had to fit every thing in one box!
2. Save yourself the headache, watch this short installation video: [DECKED.com/videohandle](https://www.decked.com/videohandle).
3. From the front face of the drawer, place the springs up and into the cavities on either side of the handle slots, red spring=right spring.
4. Install a clevis pin through each outside drawer hole and through the spring to hold the spring in place. Do not push through 2nd hole yet. If it's sticky you may need to lightly tap the clevis pin to get it threaded.
5. With the DECKED logo facing outward, insert the handle ends behind the spring arms. Hook the spring arms into the handle notches and rotate the arms of the handle toward the clevis pins, which will pull the spring arm downward and load the spring with pressure.
6. When the handle hole is aligned to the clevis pin, push the pin through the handle hole and through the inside drawer hole. Repeat on the other side of the handle. If it's sticky you may need to lightly tap with a hammer to get it all the way through.
7. Install a hair pin through each clevis pin. Check function, make sure your handle is snappy.

**HARDWARE BAG  
HANDLE, HANDLE HW**

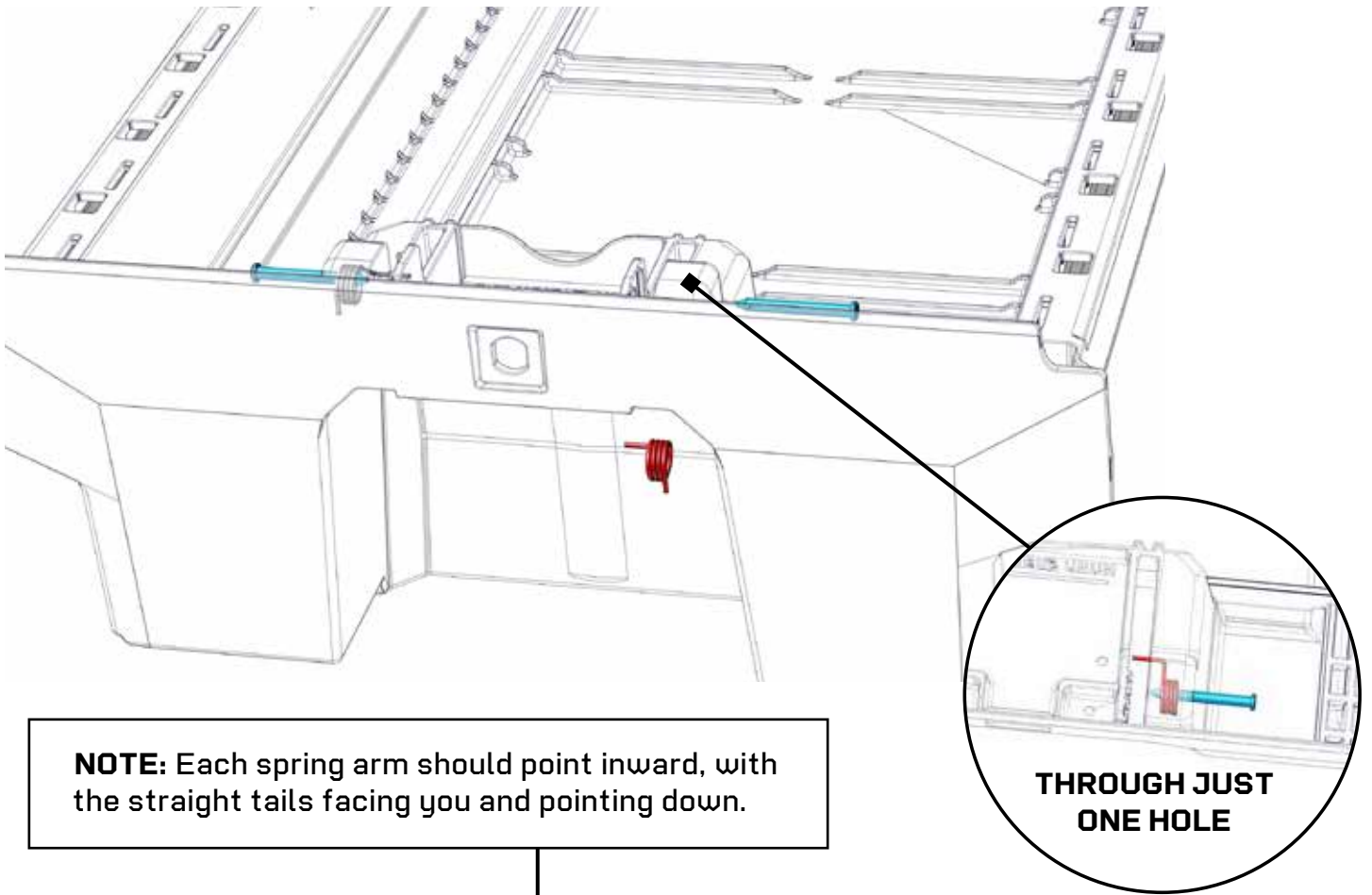

**NOTE:** Each spring arm should point inward, with the straight tails facing you and pointing down.

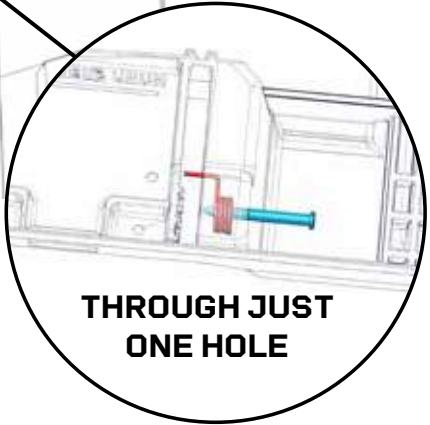

**THROUGH JUST  
ONE HOLE**

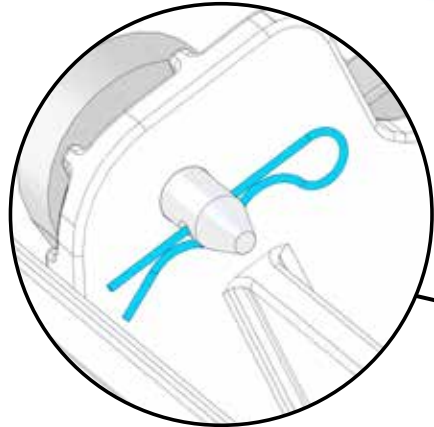

**ADD HAIR PIN**

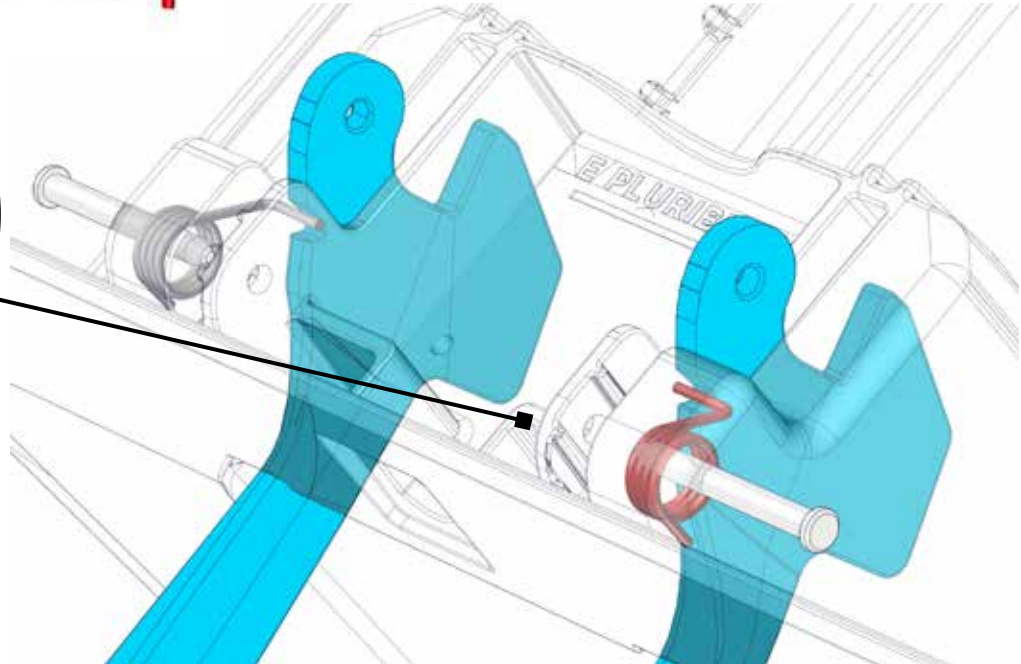

# STEP 6:

# IT'S INSTALL TIME

---

1. Hook center vert tabs into cabside closeout panel slots and push vert down to engage.
2. Place the vert assembly into the back of your truck with the T at the cabside end.
3. Find a friend to help you lift the driver's side panel assembly into the back of the truck.
4. Hold the assembly at an angle, with the panel center (zig zag side) raised slightly higher than the outside of the panel.
5. Walk the assembly to the cabside, ensuring the top of the cabside closeout panel is seated fully below the cabside portion of the deck panel.
6. Make sure that the pre-installed center vert and panel gaskets are seated in place. Seat the zig zag edge of the panel onto the vert bosses. Press down so it seats entirely and satisfyingly.
7. Install the passenger side assembly in the same manner.
8. Install either 12 or 14 bolts from the BOLTS bag into each of the holes down the zig zag center, depending on your truck bed length.



**HARDWARE BAG  
BOLTS**

**CABSIDE**

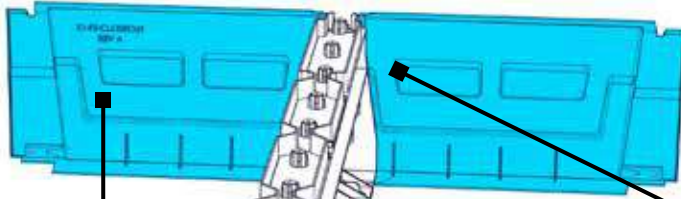

**CABSIDE CLOSEOUT PANEL**

**CENTER VERT**

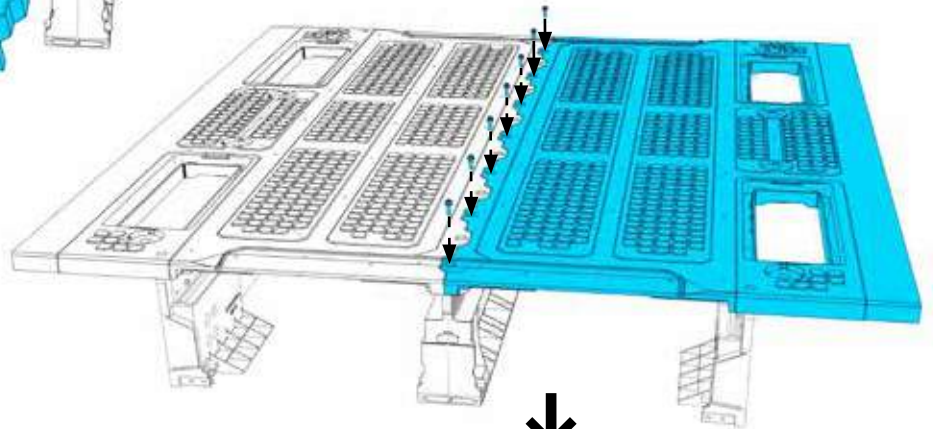
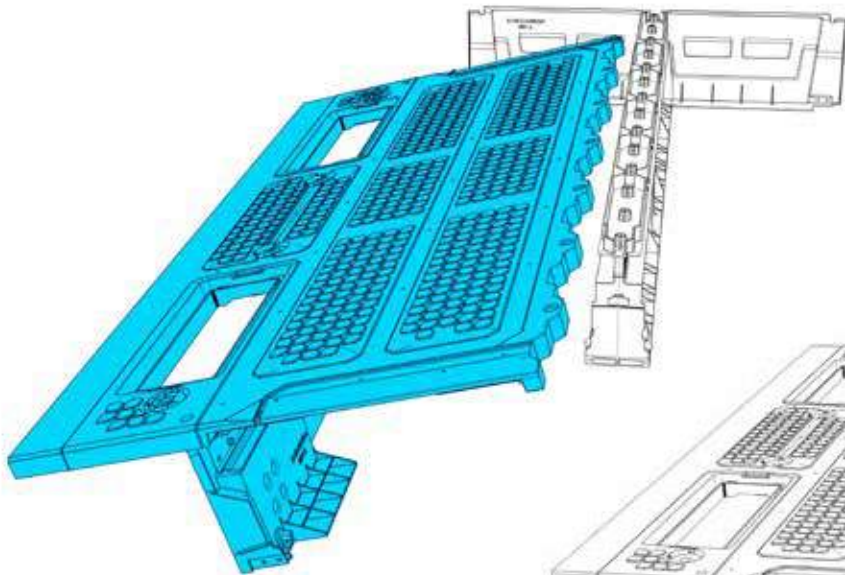
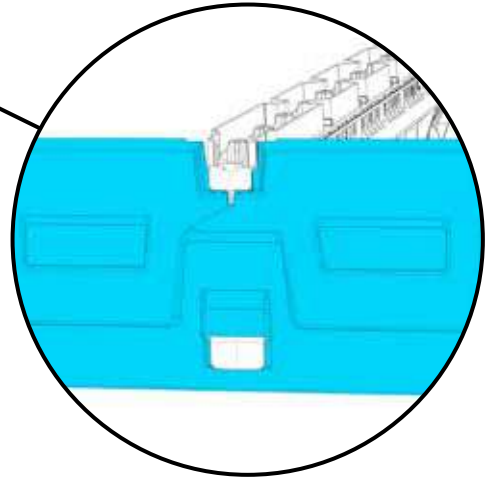
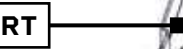

**TAILGATE END**

# STEP 7:

## DRAWERS MADE TO ORDER

---

1. Install one drawer at a time.
2. Holding the drawer level with the panel, carefully support the drawer while rolling the wheels into the channels. Seat the drawer into place.

**NOTE:** Do not attempt to open/close the drawers until all tailgate wheels are installed.

3. Use a stash bin lid or a friend to prop the drawer up. Install the four LITTLE wheels under the drawers using the 7/32" hex key.
4. Repeat with the other drawer.
5. Perform two karate high kicks.

**TECHNIQUE TRICK:** Get the drawer pressed all the way up against the deck panel and make sure you have not placed the weatherstrips on the drawer lip yet. If you have man hands, press the wheel against the axle to start the threads using the driver.

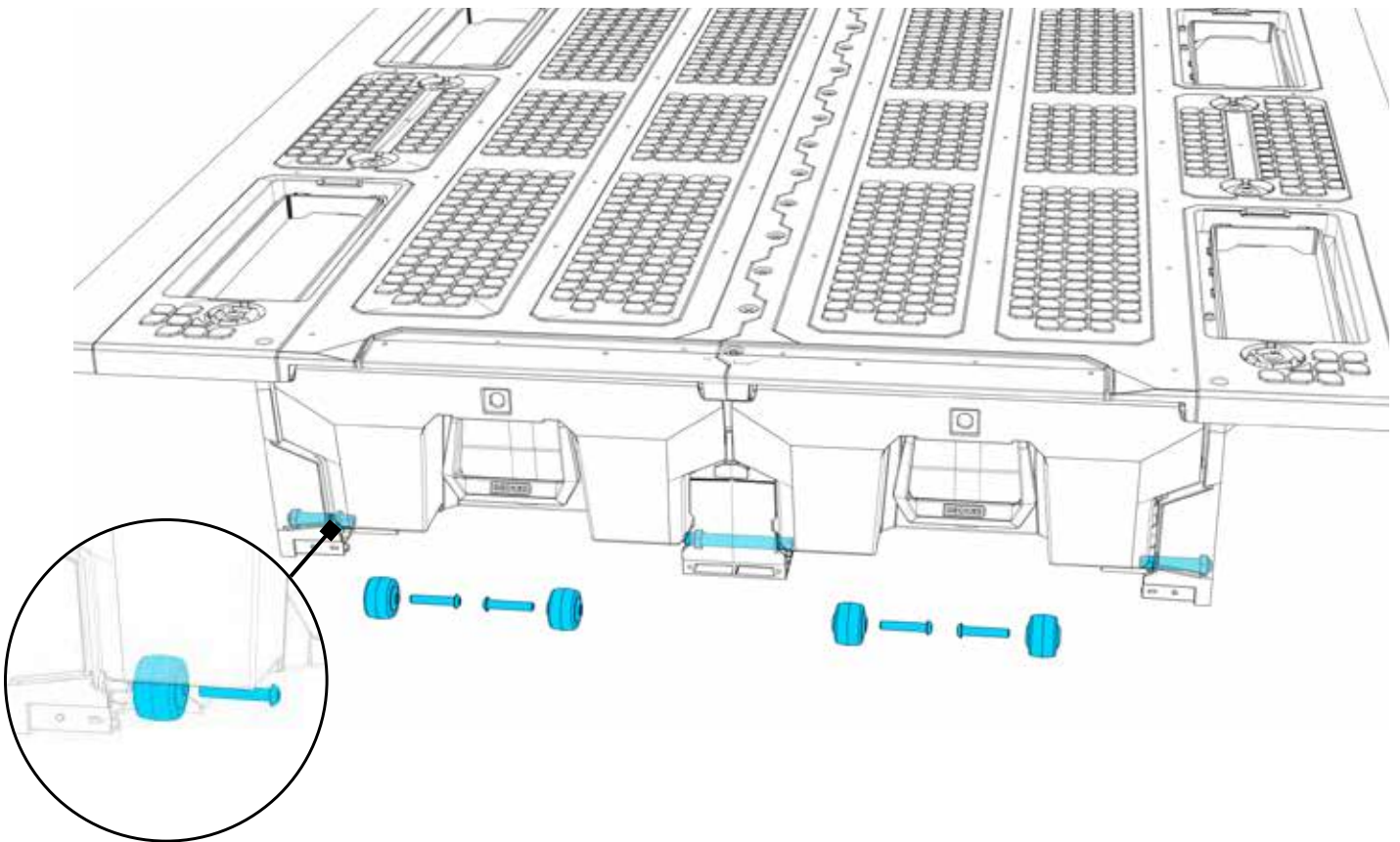
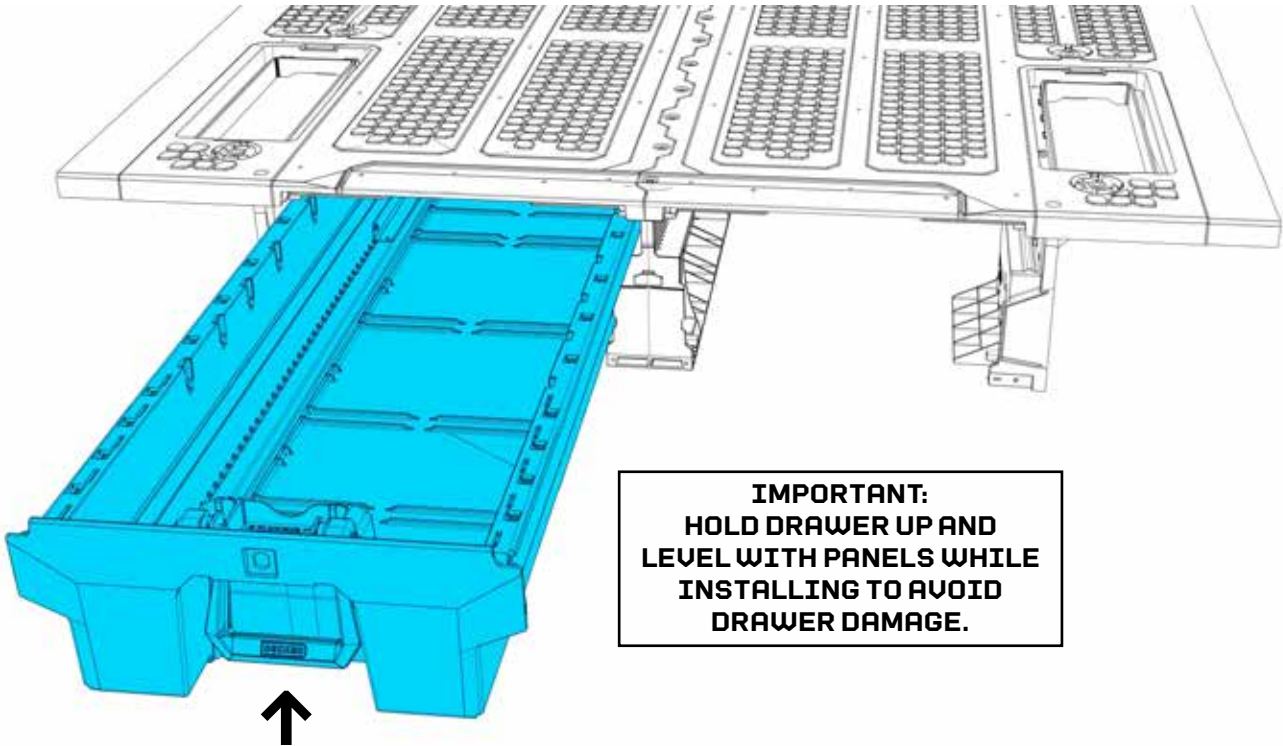

# STEP 8:

# PUT THE MUSTARD

# ON THE DOG

---

1. Install the ruler with four 3/16" hex drive screws. Do not over torque, torque boy. Just get 'em snug.
2. Position the torsion brace such that the holes are facing you and the angle is under the center vert and corner feet. The hole-free side should be hidden underneath.
3. Slide the top of the codpiece under the lip on the center vert. Hold the codpiece in place and install two 1" long, 3/8" hex head screws through the codpiece and torsion brace and into the center vert. Do not tighten completely.
4. Install the torsion brace ends with the same hex head screws. Do not tighten completely.
5. Once you have the torsion brace where you like it, check to make sure the edge of the feet are plumb vertically, adjust as necessary. Once you are happy go back and tighten completely.
6. Install weatherstrips onto drawer lip. Work from one end to the other, pressing firmly in place. Make sure the point of the weatherstrip is angled towards the cab.
7. Stand back and say, "YUP" with your hands on your hips.

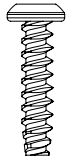

Hex drive



Hex head

**HARDWARE BAG**  
FS SCREWS

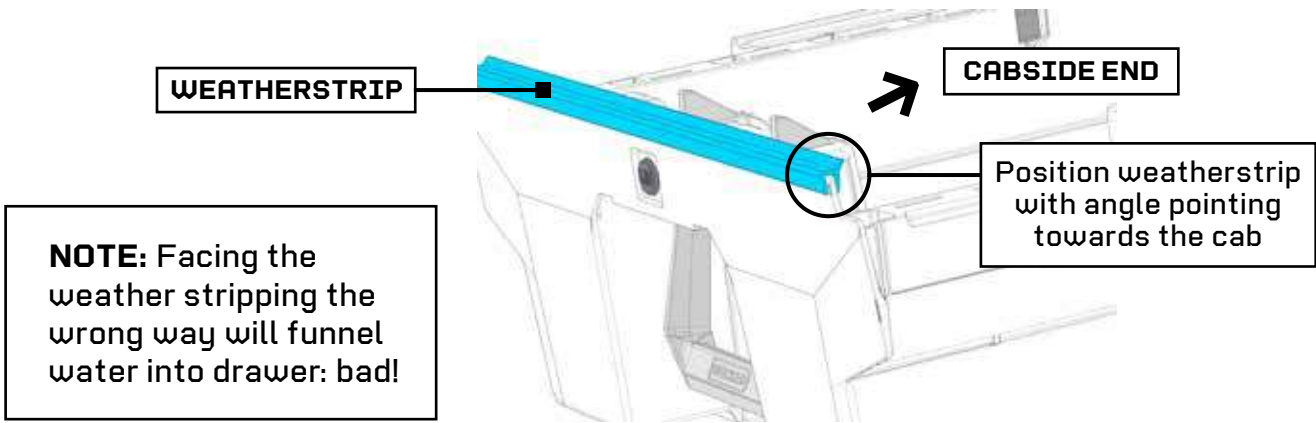
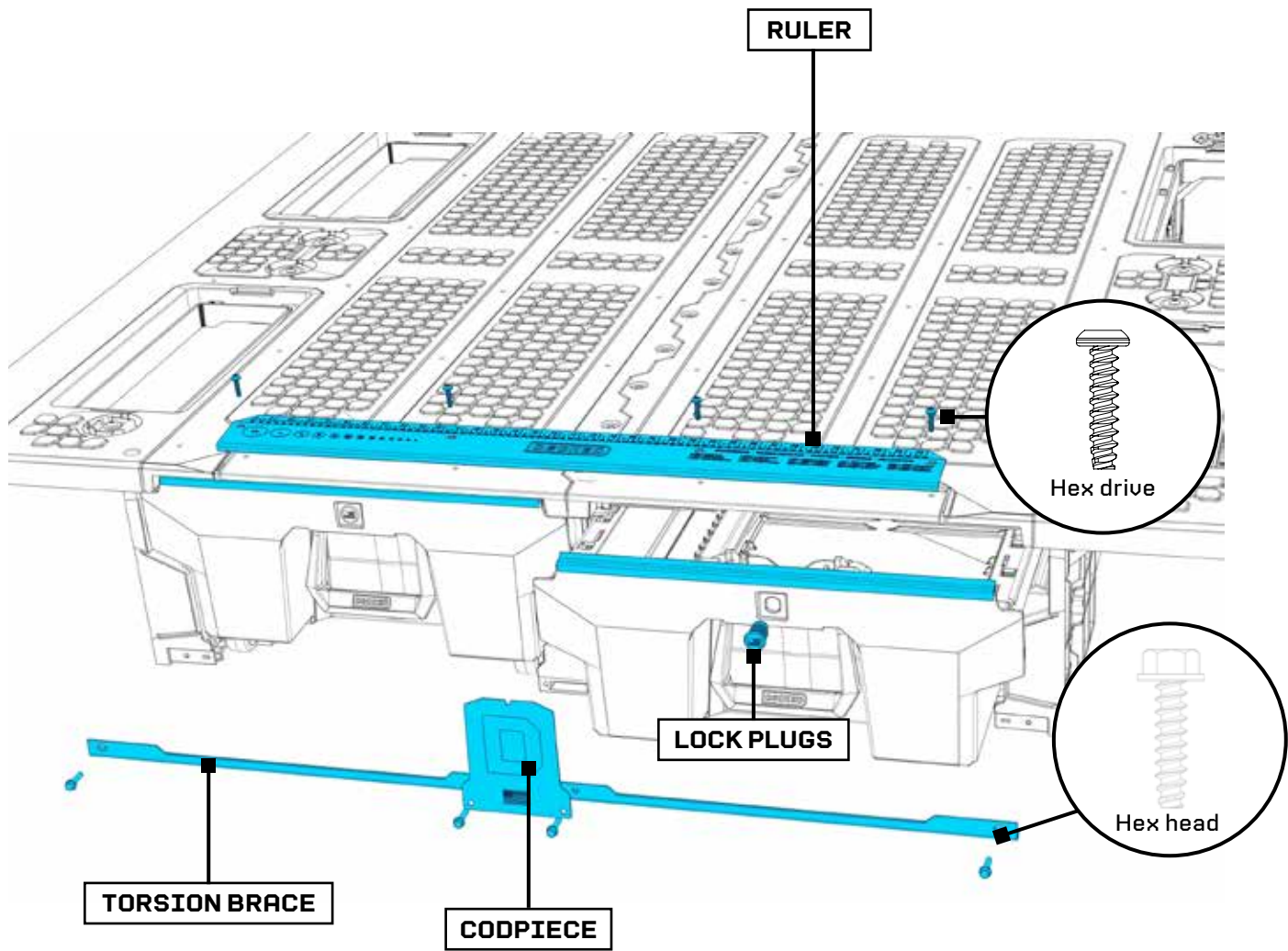

# STEP 9:

## TURNBUCKLE WRASSLIN'

---

1. Install turnbuckles into the four corners of the system. Use the shorter turnbuckles at the cabside.
2. Center the system in your bed referencing center by the ribs or troughs to the center of the system, NOT the distance to the sides of the bed from the system.
3. Set turnbuckle jam nuts to their outermost position.
4. Match the lengths of each threaded end in the turnbuckle. Adjust turnbuckles by holding each hook in a hand and then tighten or loosen by rotating the “takeup” without allowing hooks to rotate.
5. There are round turnbuckle holes on each side of the C-Channel tie down bracket. Hook one side of the turnbuckle through one of the round holes. You may have to use the other round hole, depending on the length you need. Hook the other side onto the DECKED replacement or factory cabside tie down bracket. Install the other tailgate and cabside turnbuckles the same way.
6. Tighten by rotating take up. There is a small “R” stamped on the turnbuckle to help identify which end is “righty tighty lefty loosey”. Once you like how the system is centered, tighten completely by hand then take a wrench and tighten one more complete turn of the take up.
7. Tighten jam nuts against the take up firmly.
8. Install the four stash bin lids. Install stash bin plugs or locks (if you purchased these).
9. Slap yourself high five.

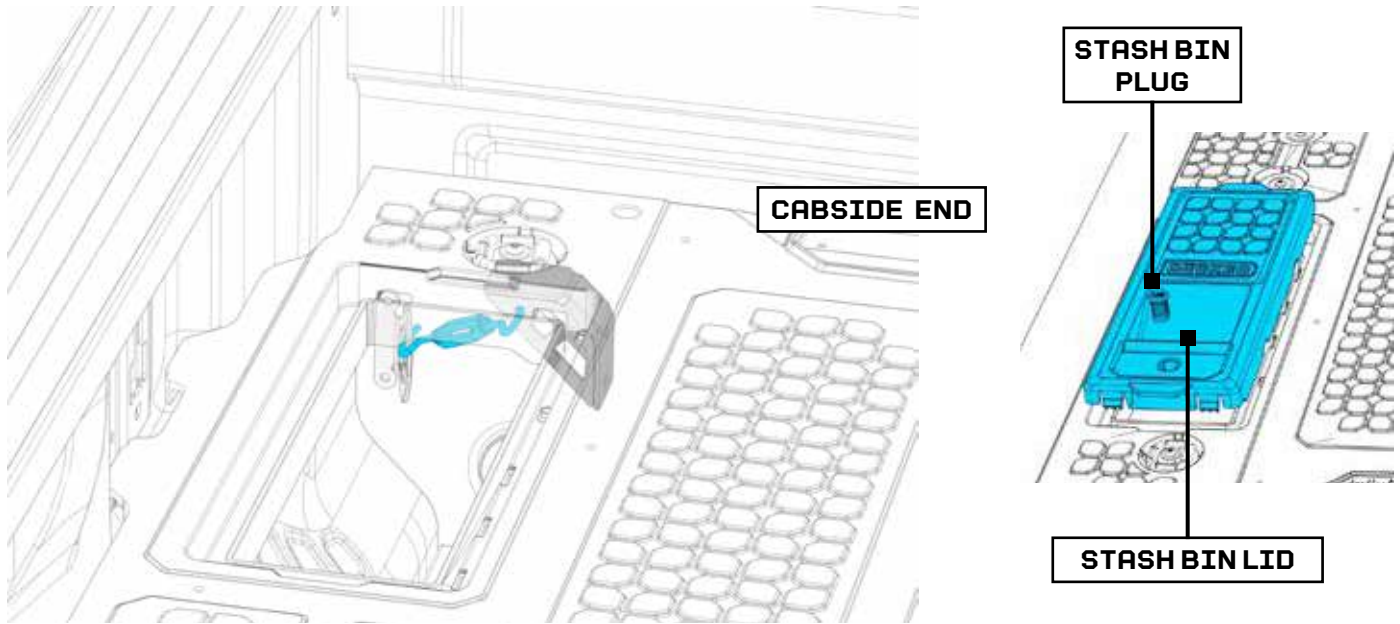

Your tie down might look different than the one shown in the image.

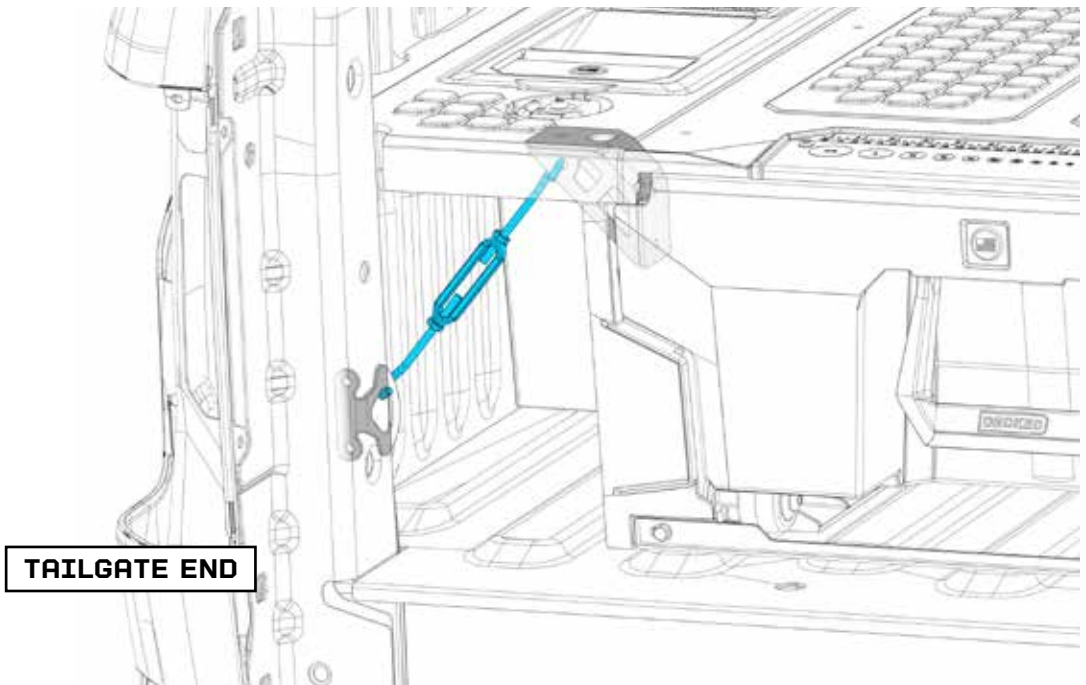

# CONGRATS, GAME CHANGER! YOU DID IT.

Crack open a cold one of your liking, sit back and admire your work. Now get busy organizin'!



# DECKED PRODUCTS LIMITED LIFETIME WARRANTY

(Valid on DECKED Products purchased on or after 8/1/2021)

DECKED LLC, (the "Manufacturer") warrants the original purchaser only that DECKED Truck and Van Products (The "DECKED" Product) will be free from defects in material and workmanship from the date of purchase and continuing for the expected lifetime of the DECKED Product. The DECKED Product must be registered by the original purchaser with DECKED, LLC via its website at, [decked.com/register](https://decked.com/register), and a copy of the original sales receipt must be supplied to the Manufacturer at the time a warranty claim is made. This warranty terminates if the original purchaser transfers the DECKED Product to any other person or vehicle.

## WHAT IS COVERED

All DECKED Products identified above on or after August 1, 2021. **DECKED's Limited Lifetime Warranty applies to US and Canadian customers only. International shipments are covered by DECKED's 3 Year Limited Warranty.**

## WHAT WE WILL DO TO CORRECT PROBLEMS

Subject to the limitations and exclusions described in this limited warranty, the Manufacturer will remedy defects in workmanship or materials by providing one of the following remedies at its option and without charge to the original purchaser for parts: (a) repairing the defective portion of the DECKED Product or (b) replacing the entire DECKED Product. In addition, the Manufacturer may elect at its option not to repair or replace the DECKED Product, but rather issue to the original purchaser a refund equal to the purchase price paid for the DECKED Product or a credit to be used towards the purchase of a new DECKED Product.

## WHAT IS NOT COVERED

This limited warranty expressly excludes:

- Damage or defects caused by normal wear and tear, cosmetic rust, scratches, accidents, unlawful vehicle operation, installation in a non-supported vehicle or installed in a vehicle which does not match the DECKED Product's SKU-intended fitment or use, or modification of the product, or any types of repair of a DECKED Product other than those authorized or provided by the Manufacturer.
- Damage or defects resulting from conditions beyond the Manufacturer's control and specifications including, but not limited to modification, misuse, overloading, or failure to assemble, install or use the DECKED Product in accordance with the Manufacturer's written instructions or guidelines included with the DECKED Product or separately made available to the original purchaser.
- Damage to the contents of the DECKED Product or vehicle.
- TO THE EXTENT PERMITTED BY LAW, IN NO EVENT SHALL THE MANUFACTURER BE LIABLE FOR ANY INCIDENTAL, SPECIAL, INDIRECT, OR CONSEQUENTIAL DAMAGES, INCLUDING ECONOMIC LOSS, WHETHER RESULTING FROM NONPERFORMANCE, USE, MISUSE, OR INABILITY TO USE THE DECKED PRODUCT OR THE MANUFACTURER'S NEGLIGENCE.

## NO OTHER EXPRESS WARRANTY APPLIES

This Limited Lifetime Warranty is the sole and exclusive warranty for DECKED Products. No employee, agent, dealer, or other person is authorized to alter this warranty or make any other warranty on behalf of DECKED LLC.

## NOTIFICATION PROCEDURES

If the DECKED Product does not conform with the terms of this limited warranty, the original purchaser must promptly notify the Manufacturer in writing upon discovery of the nonconformity. In order to receive remedies under this limited warranty, a warranty claim must have been registered with DECKED LLC by the original purchaser, must describe the nature of the products nonconformity, include a copy of the original sales receipt, invoice, or other proof of purchase and be accompanied with photos or video. Repairs or modifications made to the DECKED Product by other than the Manufacturer or its authorized agent will nullify this limited warranty. Coverage under this limited warranty is conditioned at all times upon the owner's compliance with these required registration, notification, and repair procedures.

Product registration may be performed at:  
**[decked.com/register](https://decked.com/register)**

Warranty claims must include reciprocal contact information and may be made via certified mail or email to:

DECKED Warranty and Claims  
PO Box 885  
Ketchum, ID 83340  
[warranty@decked.com](mailto:warranty@decked.com)  
208-806-0251

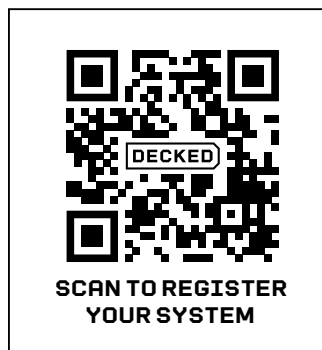

Register your system at  
[decked.com/warranty](https://decked.com/warranty)

## PATENTS

### MIDSIZE DRAWER SYSTEM:

US10988087B2, 112017005448.6, AU2017348386A1, 3042037

### FULL SIZE DRAWER SYSTEM:

US9527454-B2, USD719905 S, US9168874 B2, CA2969118A1

### TOOL BOX:

US20210062581A1

For more information on our patents visit: [decked.com/patents](https://decked.com/patents)