

INSTALLATION INSTRUCTIONS*

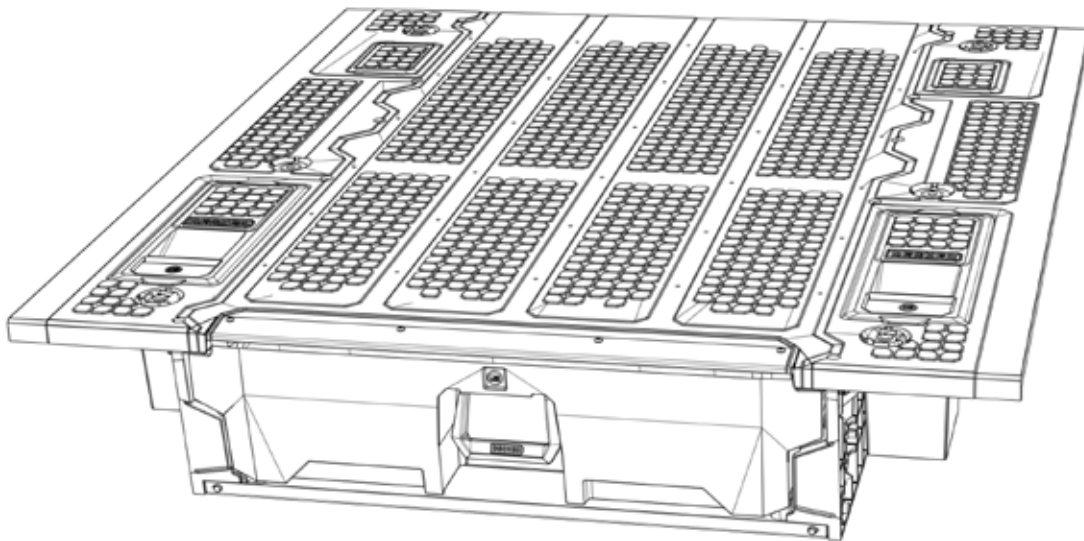

YF2/YF4
US FORD RANGER (2019-2023)
6' BED

FORD/MAZDA RANGER XL SUPER BT50 DUAL (2011-2022)
72.72" / 1847MM BED

*Trust us on this one; don't go commando and attempt your install without reading.
You'll just cuss a bunch and create even more chaos in your truck bed.

TOOLS REQUIRED

- 1/2" and 3/8" socket
- 7/16" socket and/or wrench
- 3/16", and 7/32" hex key
- Torx 40 driver
- We included a 3/16" and 7/32" hex key for your tool kit but you may prefer to use your own.
- Trusted friend with a weak mind and a strong back.

INSTALL VIDEO

High tech link to video here or you can visit decked.com/video



HEY! TORQUE BOY

READ BEFORE YOU INSTALL

Welcome to DECKED! In a world of crappy instructions, bad advice, and questionable sources of truth, we are here to make sure that your install goes as smoothly as possible, saving you headaches and heartburn. That said, your part is to read the darned instructions!

1. Only use cordless screw guns or drivers with a clutch and speed setting adjustment.
2. Set your clutch down in the bottom 1/3 of the available torque settings.
3. Set your drill speed to the slowest speed.
4. We tell you all of this to prevent you from blowing up the inserts and setting your install back. Start screws into inserts with your fingers to make sure you don't cross-thread.
5. Do NOT use pneumatic air tools or old school tools with no torque settings.
6. Drop in bedliners are not compatible and need to be removed.

*NOTE: Two extra threaded inserts are included in the PREP-EXTRA bag. That's all you get big timer, unless you call us and ask for more. The repair inserts will replace any stripped inserts in the corner support feet and the deck panel. So, hand-tighten until snug only! You can also screw the feet inserts back in if dislocated. Use a flat screwdriver to screw them back in from below.

CONTENTS

DECKED CARTON

LEFT C-CHANNEL ASSEMBLY	1
RIGHT C-CHANNEL ASSEMBLY.....	1
DECK PANEL	1
TRAY ASSEMBLY	1
SIDE WINGERS	2
TRAY HIGH SIDES	2
TRAY BACK PLATE	1
WHEEL BRACKETS	2
DRAWER BIN	1
TORSION BRACE	1
RULER.....	1
STASH BIN - DEEP.....	2
STASH BIN - SHALLOW	2
HARDWARE KIT	1
TRAY MAT	1
SIXER CASE	1
HALFRACK CASE.....	1
D-CO BIN	1

HARDWARE BOX

PREP RANGER
NUTS AND BOLTS
PREP EXTRA
XY WHEELS
MS BOLTS
D-RINGS
MS D-RINGS HW
MS SCREWS
WHEEL BUMPERS
DRAWER BIN HW
WHEEL STOPS
MS PLUGS
STUBBIES
TURNBUCKLES

ASSEMBLY OVERVIEW

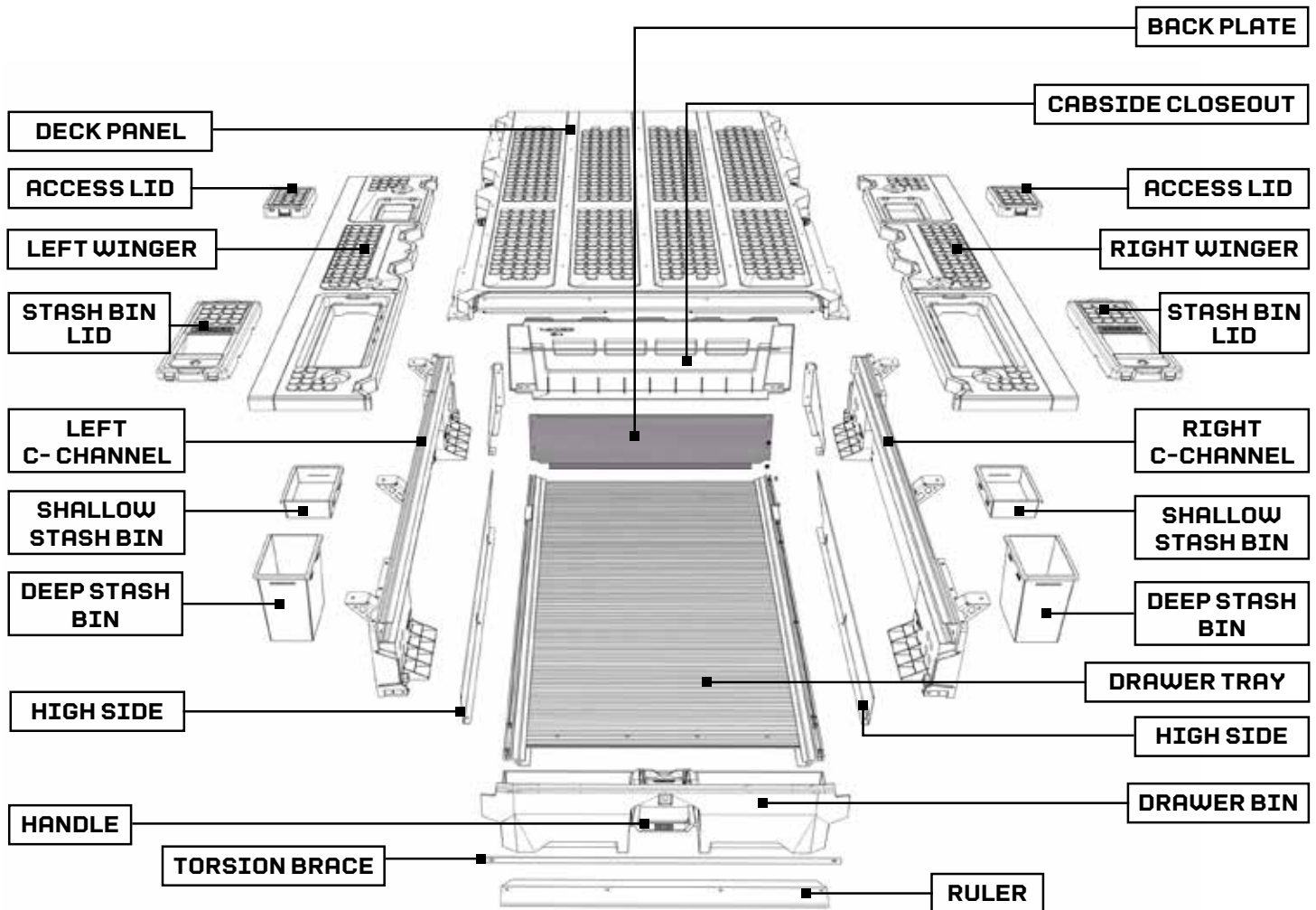

ARE YOU ADDING A CARGOGLIDE TO YOUR DRAWER SYSTEM?

1. You will need CargoGlide Mounting Brackets. If you do not have these, they are available on our website.
2. The brackets and CargoGlide can be added after installing the Drawer System into your truck bed.

INSTALL: PREP BED

1. Remove factory cabside tie downs with a Torx 40 driver. Save the bolts.
2. There is a left and right DECKED tie down.
3. Install the DECKED tie downs with the factory bolts as shown.

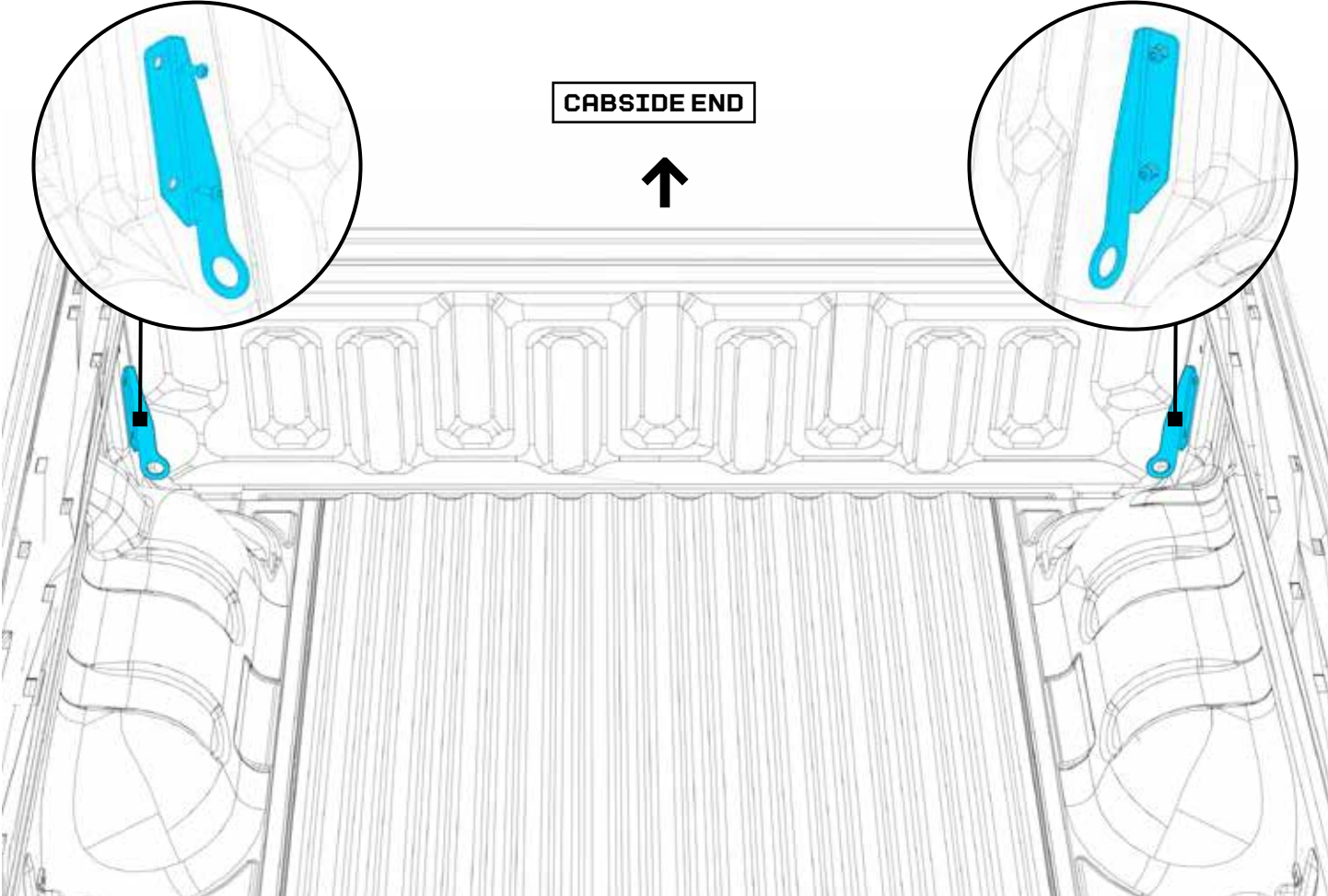
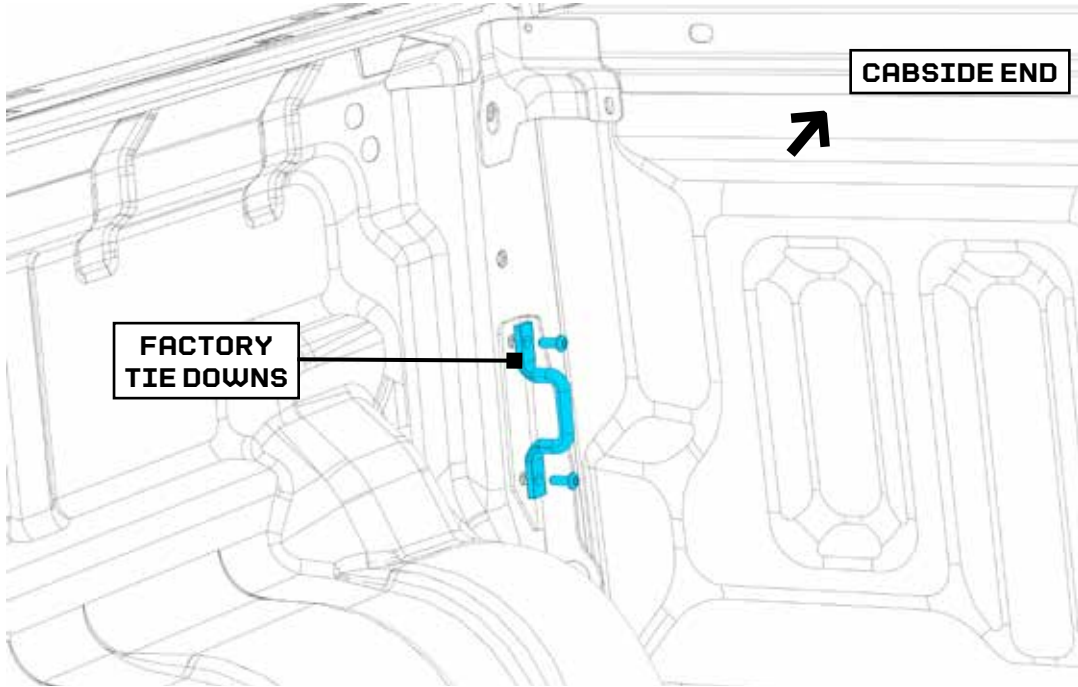

STEP 1: BE THE BOX

1. Arrange side assemblies on a flat surface with both wheel axles on the tailgate end.
2. Use the 1" bolts in the NUTS AND BOLTS bag. These may be black or zinc. Install two 1" bolts through the horizontal slotted holes in the C-Channel just inbound from the cabside and tailgate installed tie downs where shown. Install a flanged nut on the outside of the C-Channel/foot. The slotted holes may be on the top or bottom of the C-Channel, depending on the side.
3. Tighten all pre-installed C-Channel nuts and bolts EXCEPT for the tailgate end; leave all three tailgate nuts/bolts loose on each side. Verify the tie downs are plumb and level with the tops of the C-Channels when tightening bolts. If winger panels don't lie flat in later steps it may be because your tie downs aren't level.
DETAIL A.
4. Install SMALL wheels and bolts.

Leave all
tailgate bolts
loose for now.

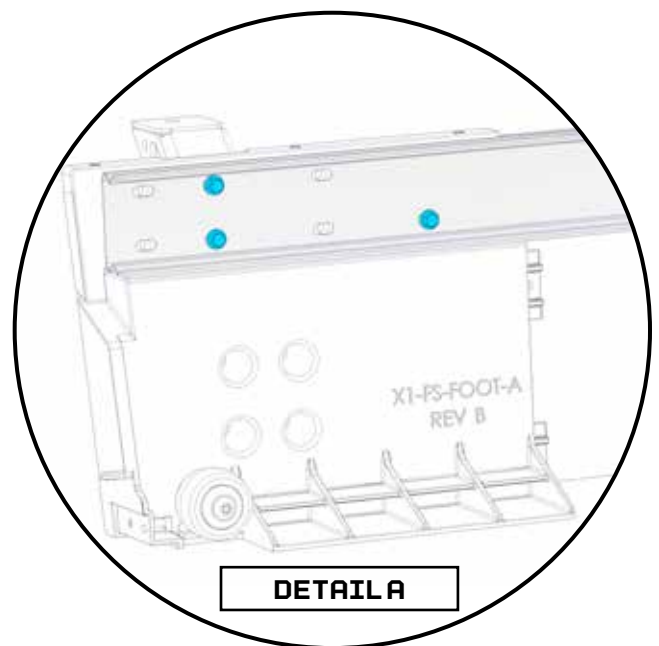

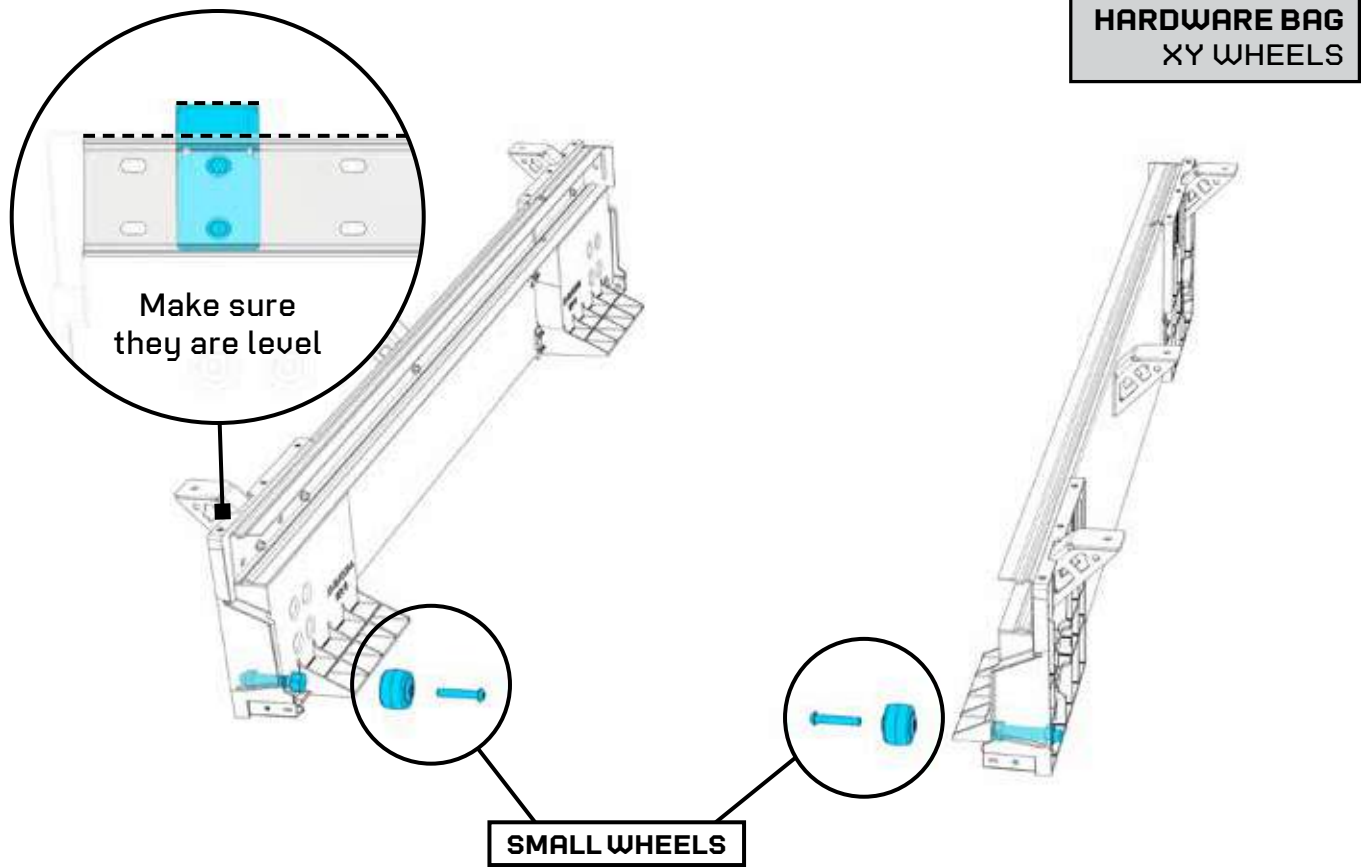
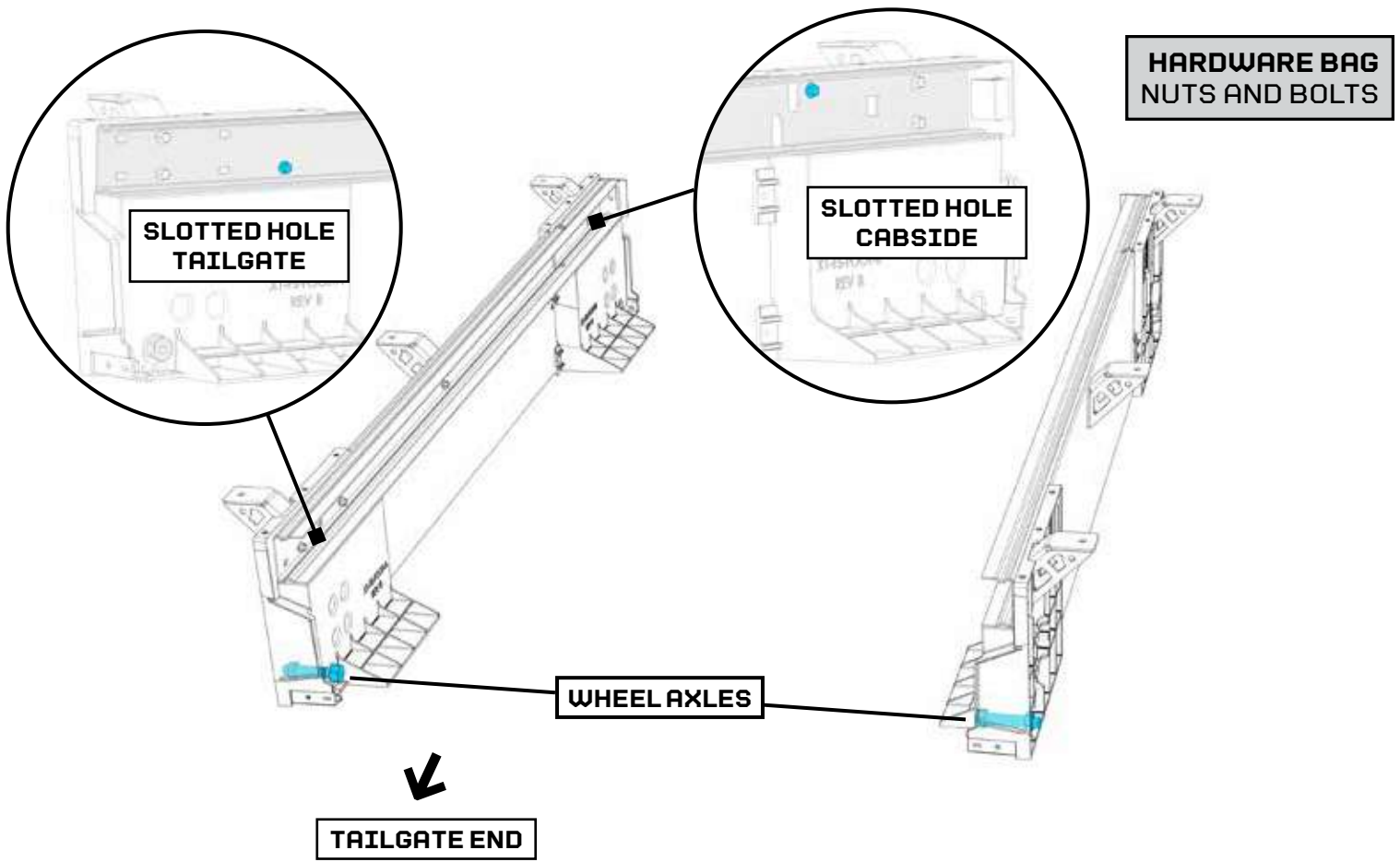

STEP 2:

CLOSE IT OUT

1. Install the cabside closeout panel with two hex head screws.
2. These are being installed directly into the polymer; DO NOT OVER TIGHTEN.
3. NOTE: If you purchased locks install the panel striker plate now from your lock hardware bag onto the underside of the deck panel. Refer to the lock instructions.
4. Place the deck panel on the assembly - ruler plate location on the panel goes on the tailgate end.
5. Shift the tailgate feet if necessary to align the inserts in the feet to the mounting holes in the panel.
6. Stretch your hamstrings.

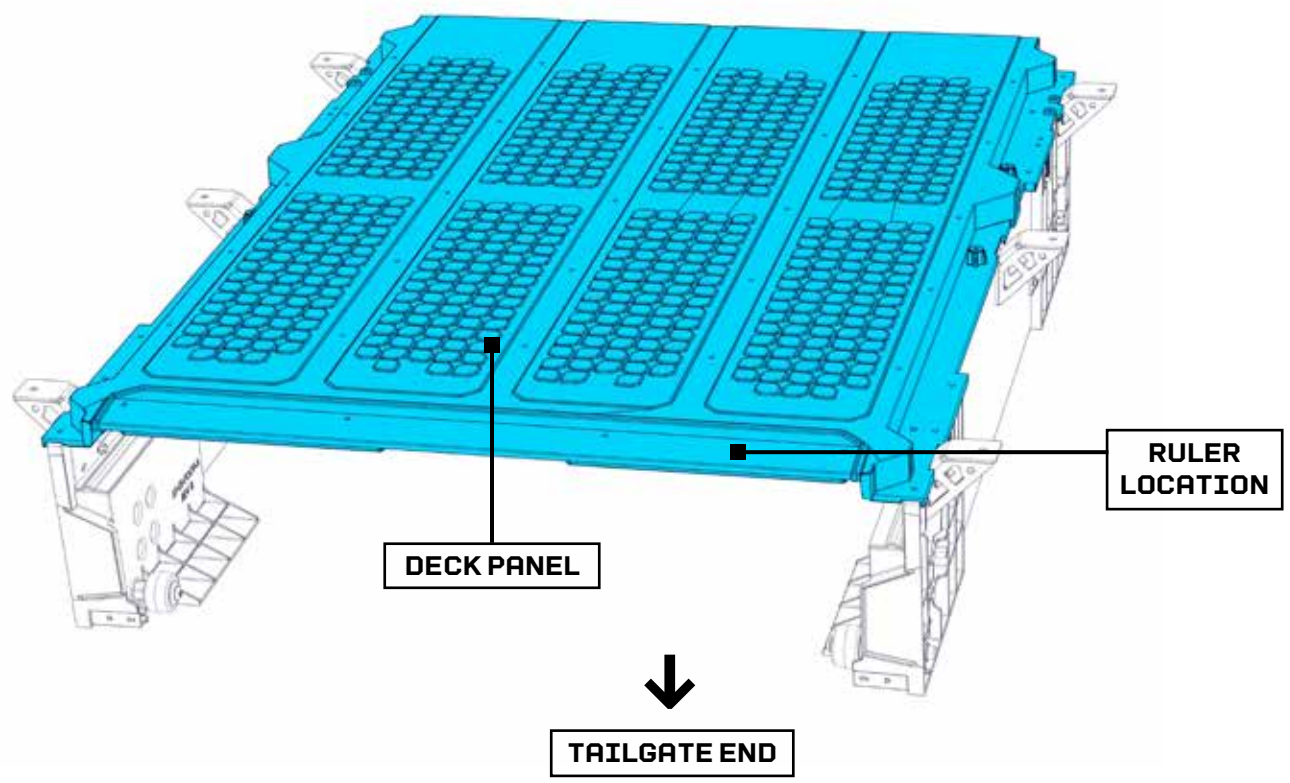
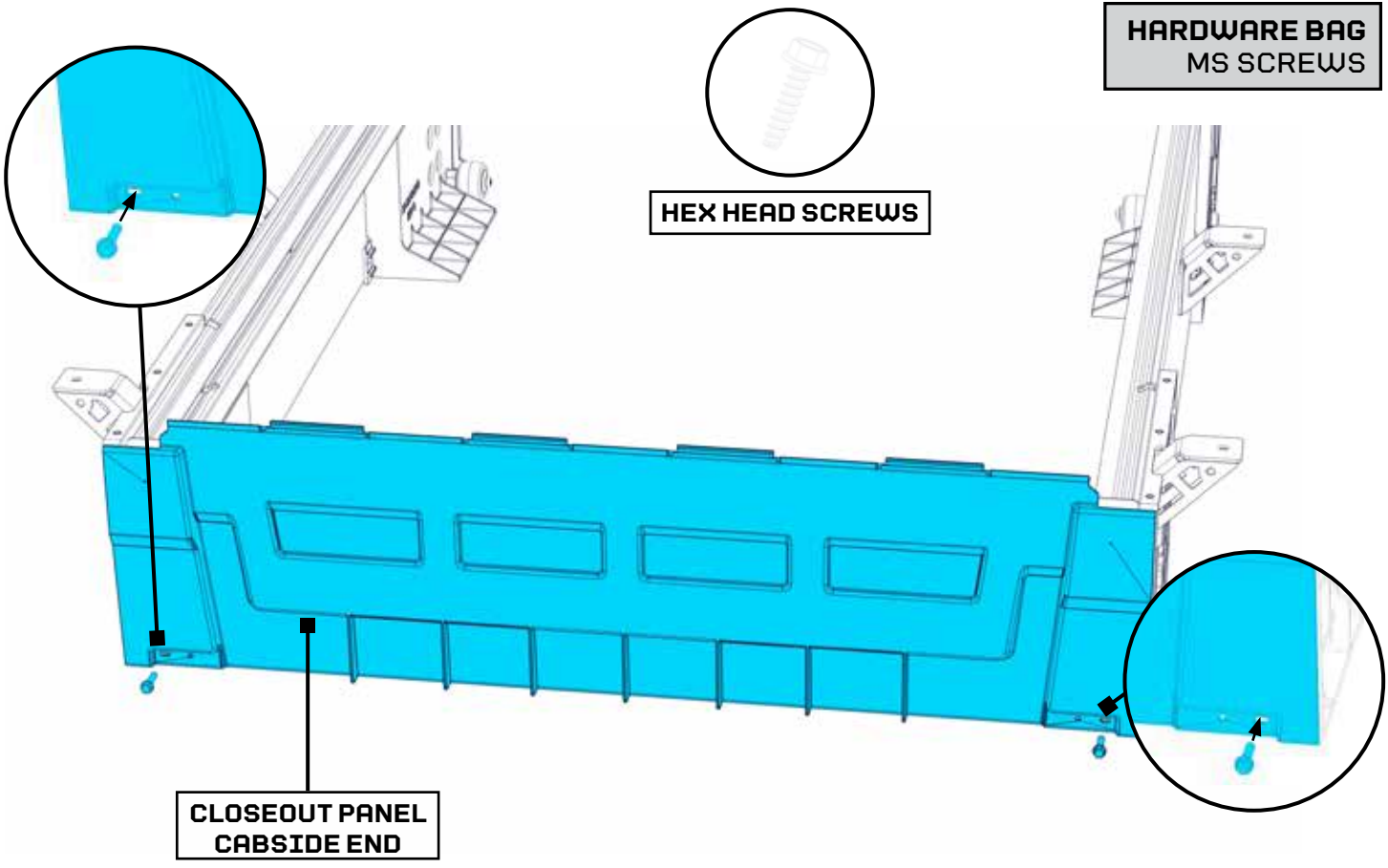

STEP 3:

BIG DECK ENERGY

1. Use four bolts from the MS BOLTS bag, one in each corner at the triangle marks **ONLY**, to install the deck panel to the inserts in the corner feet. Refer to diagram for correct placement. Tighten just until snug.
2. Tighten the three tailgate side C-Channel nuts and bolts on each side, ensuring the tie downs remain level.
3. Use the hex head screws from the MS SCREWS bag to install the torsion brace onto the tailgate side of the assembly. Slide the torsion brace under the assembly with the holes facing you.
4. Install the stubbies into one side of the panel assembly.
5. Push stubbies inward and make sure they are fully seated.
6. Short beds will have 6 stubbies.
Long beds will have 8 stubbies.
7. Grab your trusted friend and carefully carry and place this assembly into your truck bed.
8. Install the remaining stubbies into the other side. Promise said friend one more beer to help you lift the side of the assembly to insert remaining stubbies.



HARDWARE BAG
MS BOLTS, MS SCREWS

DECK PANEL

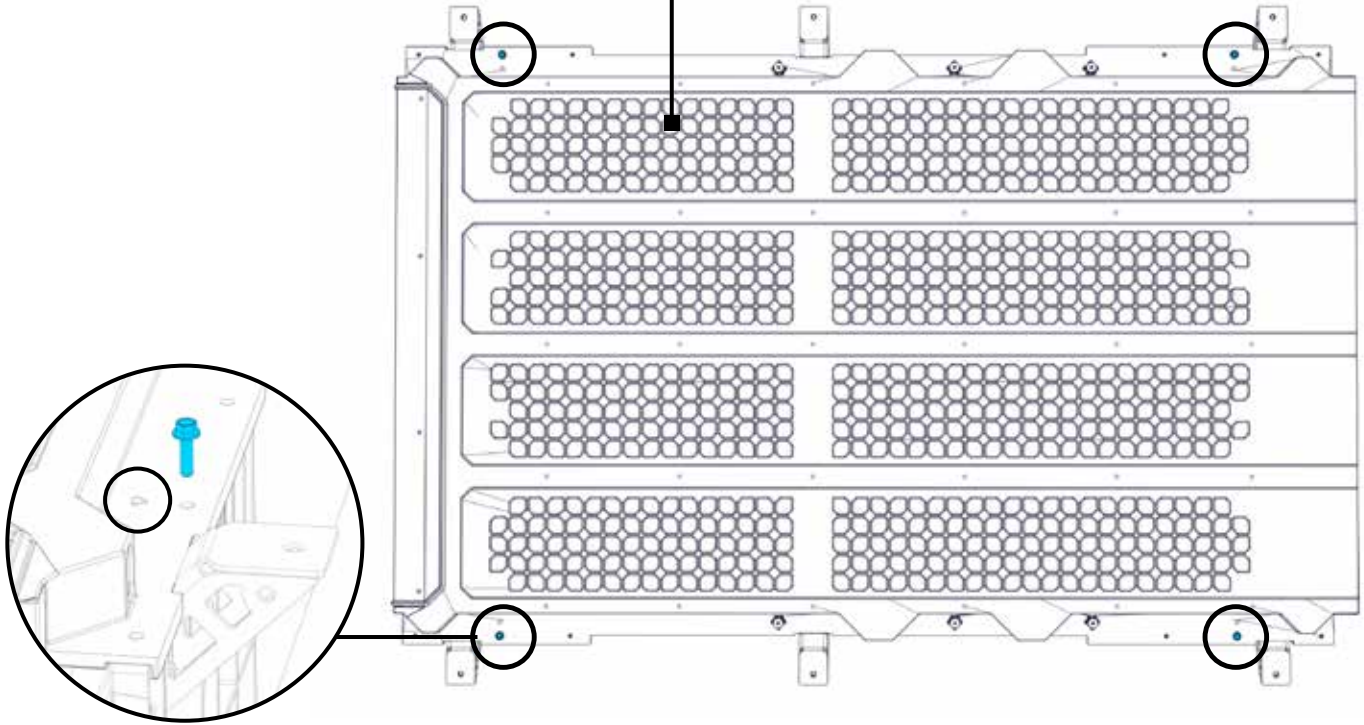

STUBBIES

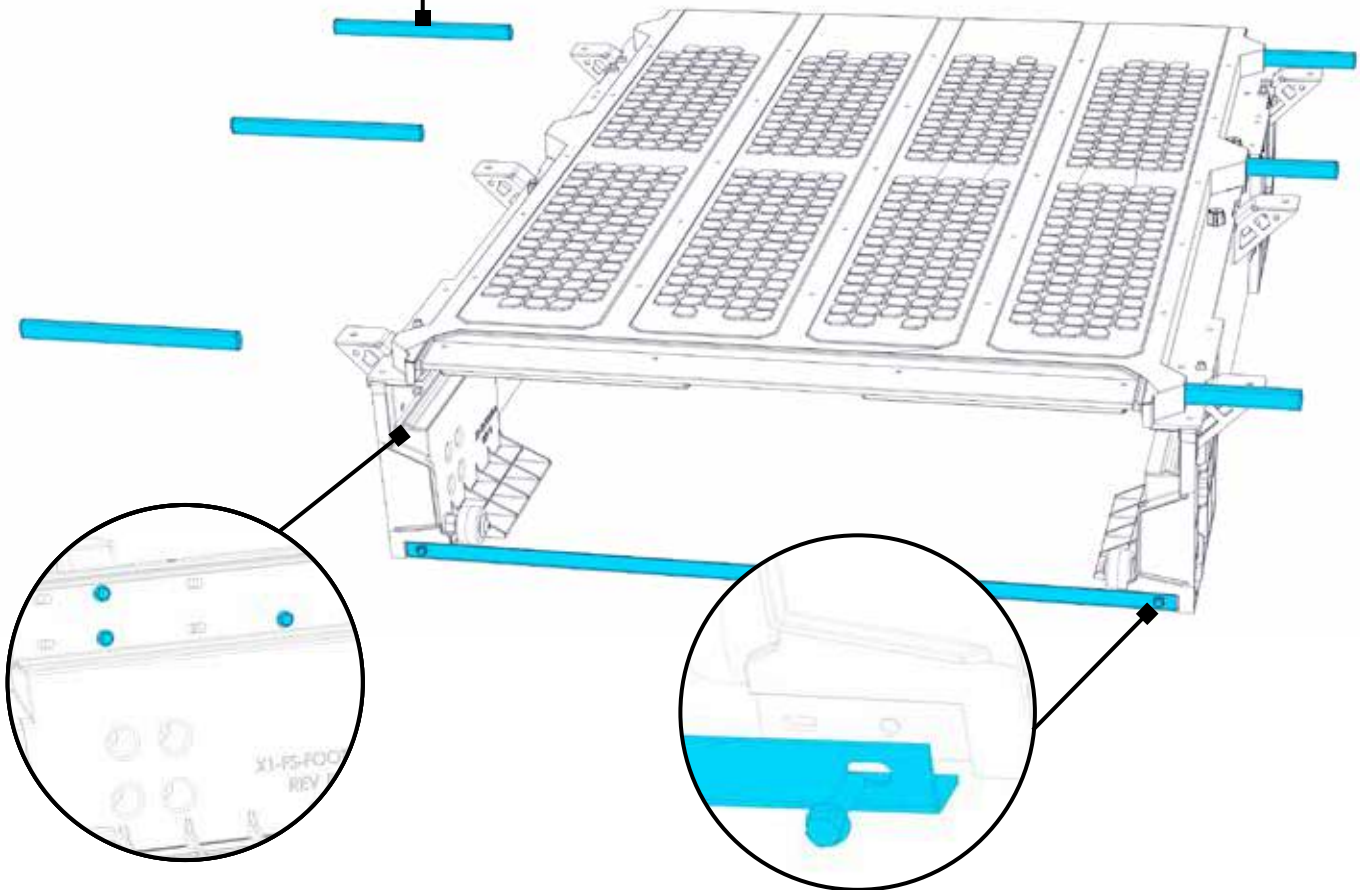

STEP 4:

TIE 'ER DOWN

1. Attach cabside turnbuckles.
2. Use the longer turnbuckles at the cabside and the shorter ones at the tailgate side.
3. Open the turnbuckle by first unscrewing the jam nuts to the most open position - towards the hooks.
4. Match the lengths of each threaded end in the turnbuckle. Adjust turnbuckles by holding each hook in a hand and then tighten or loosen by rotating the "takeup" without allowing hooks to rotate.
5. Adjust turnbuckle to approximately the correct length to reach from the round hole in the DECKED tie down bracket to the bed bracket.
6. Only fully tighten the cabside turnbuckles at this point. Hook one end of the turnbuckle through one of the round holes and the other end through the bed bracket. You may have to use the other round hole, depending on the length needed.
7. Verify the system is centered.
8. Loosen and retighten the cabside turnbuckles to center the system if necessary. Once you like it, tighten the turnbuckles completely by hand and then add one more complete turn with a wrench or screwdriver.
9. Tighten jam nuts firmly against the take up.
10. Install tailgate turnbuckles. Leave loose for now.

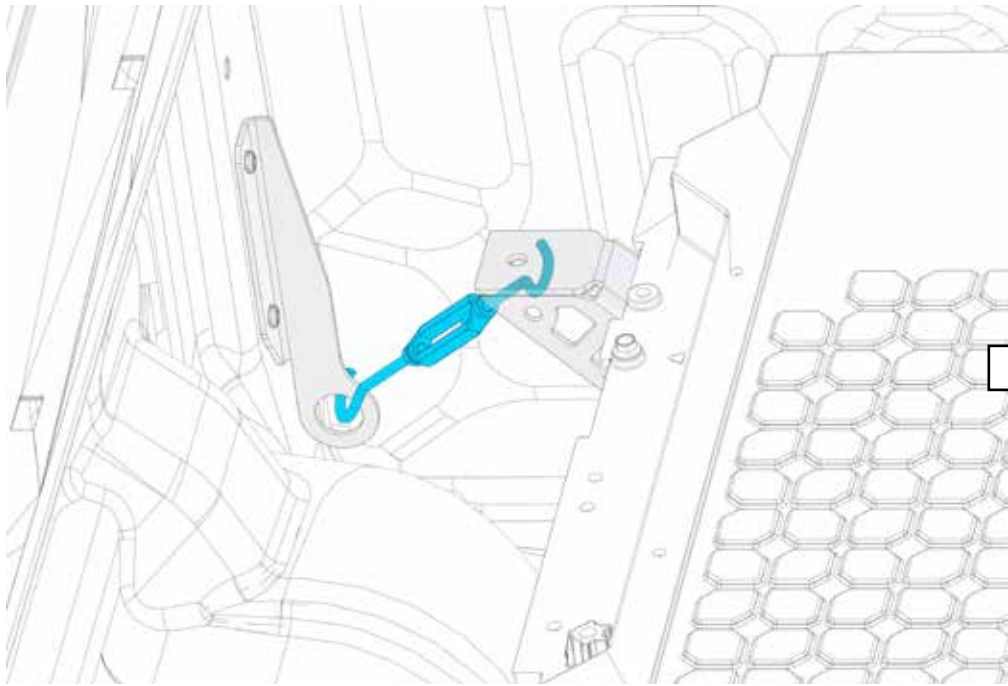

CABSIDE END

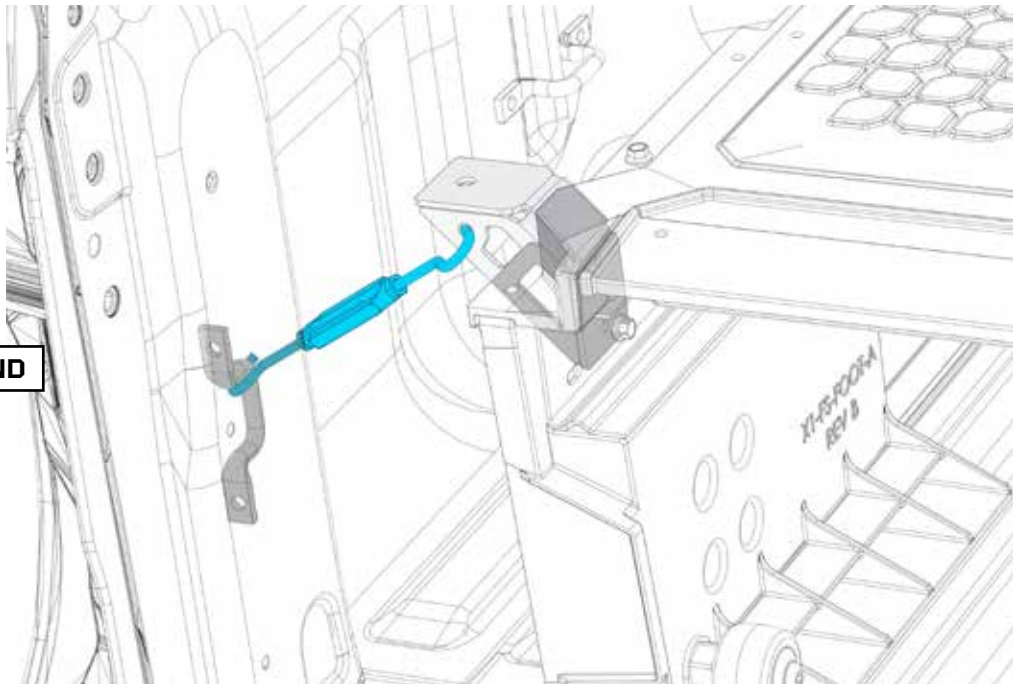

TAILGATE END

STEP 5: TIME TO WING IT

1. Place the wingers on the assembly.
2. Remove stash bin and access lids from the wingers. You can use a screwdriver or other pointy object to remove the access lids.
3. Use the remaining bolts to install the wingers to the assembly.
4. You'll have two extra if you have a short bed.

HARDWARE BAG
MS BOLTS

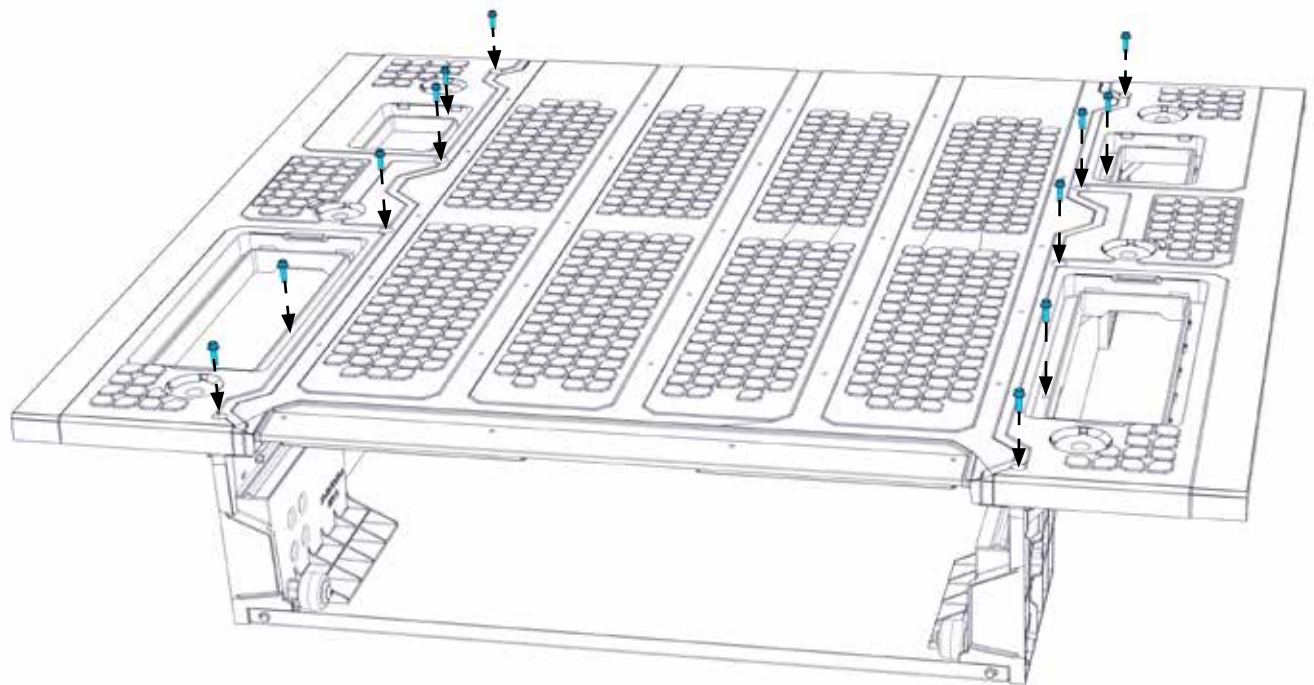
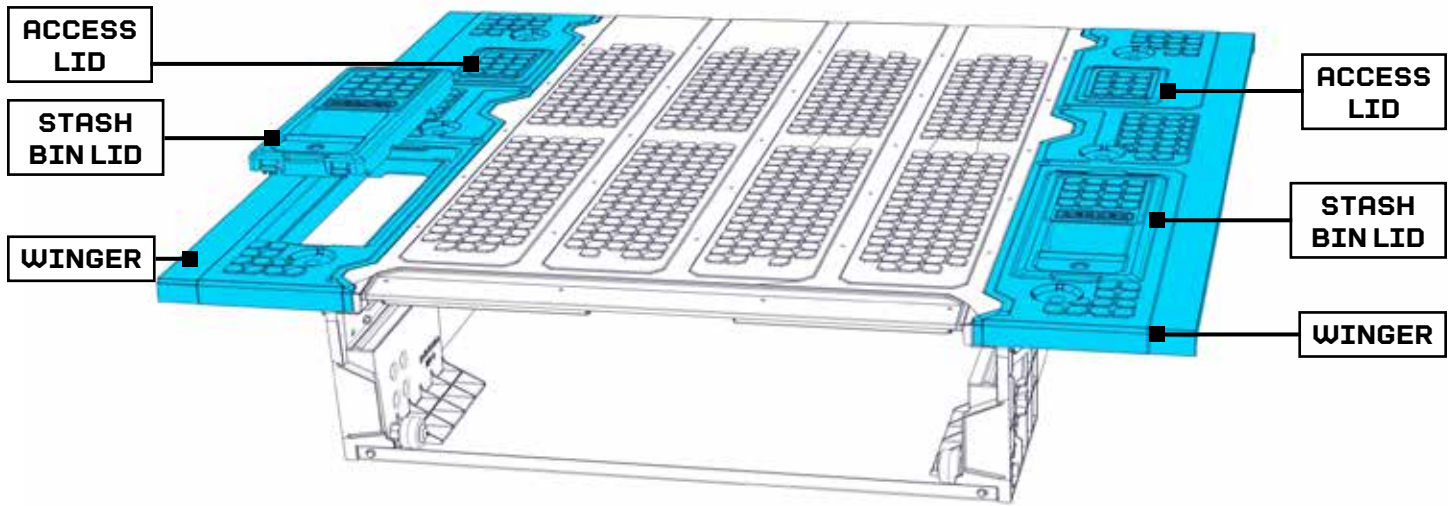

STEP 6: RING THE BELL

1. D-Rings may be installed in any of the six locations depending on your liking. Most sane people use the four corners. You can purchase additional D-Rings on our website.
2. Install D-Ring flat side down on top of silver spacer. Then place small black washer on top of D-ring and fasten with bolt. Tighten fully with a 3/16" hex wrench (included in your hardware kit).
3. Install the large black washers and bolts in the unused tie down locations.

HARDWARE BAG
D-RINGS, MS D-RINGS HW

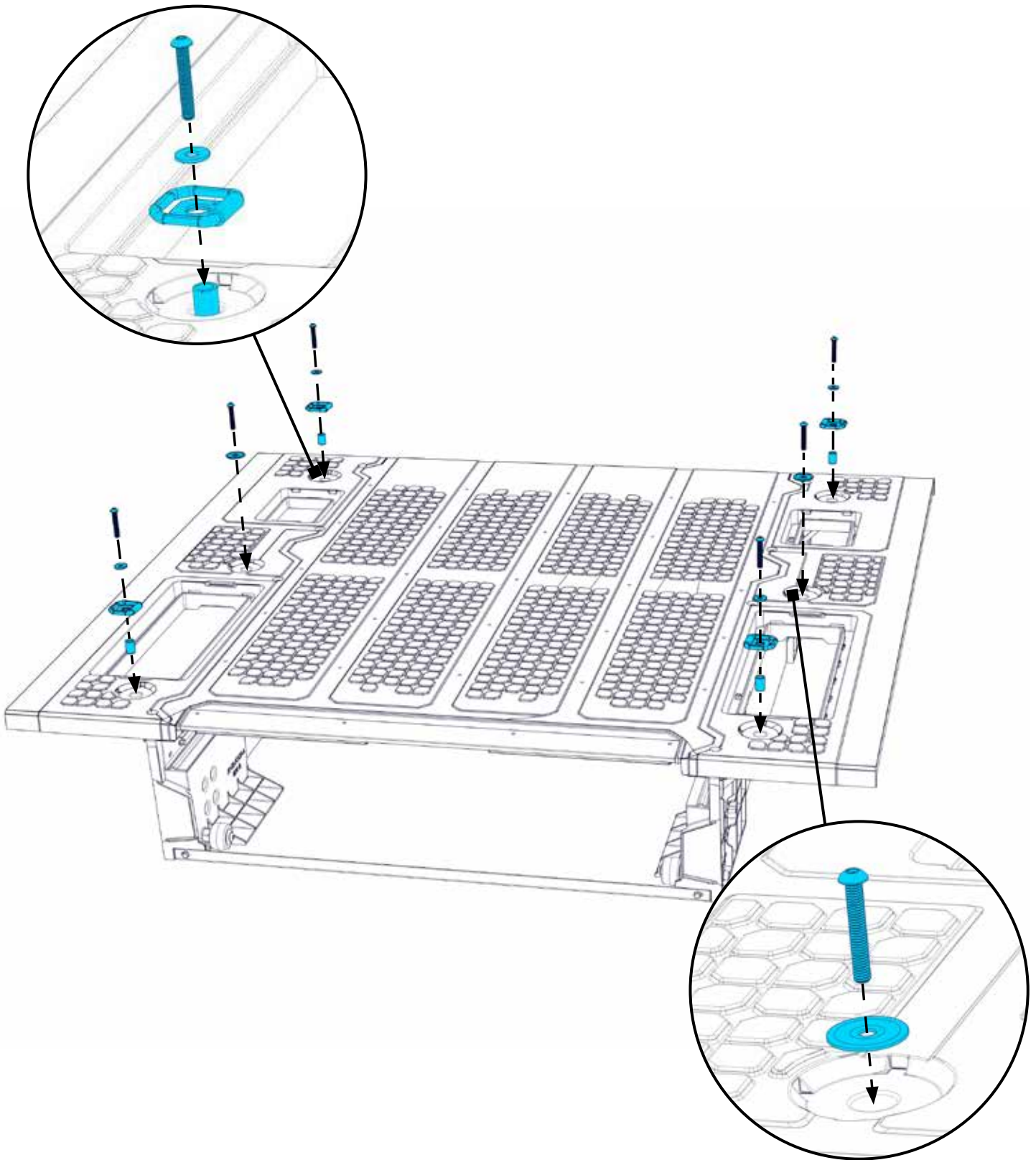

STEP 7:

BUILD THAT DRAWER

1. Use a 3/16" hex wrench to loosely install the 3/4" long screws through the inside of the drawer bin and into the weld strip below the bin. **Leave loose.**
2. The end of the tray with the four mounting holes is the tailgate end. Install drawer bin on this end. While supporting the drawer bin, evenly insert and slide the weld strips into each tray channel on the tailgate end of the assembly.
3. Push the tray up from below to seat it into the tabs.
4. Seat the aluminum side channels and tray fully against the bin and in the bin tabs.
5. Make sure everything is even before tightening the four weld strip screws.
6. Flex for the neighbors.

**HARDWARE BAG
DRAWER BIN HW**

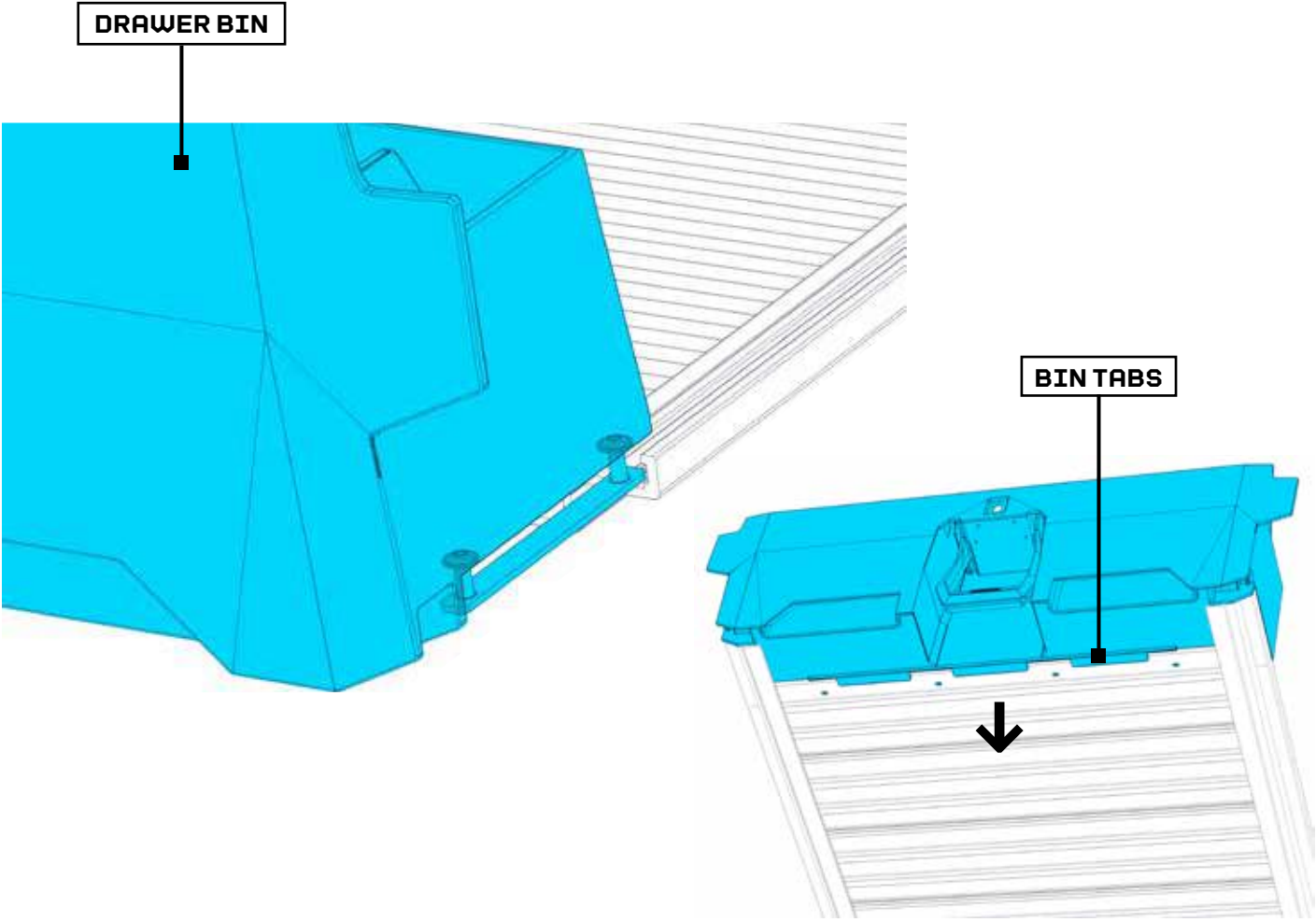
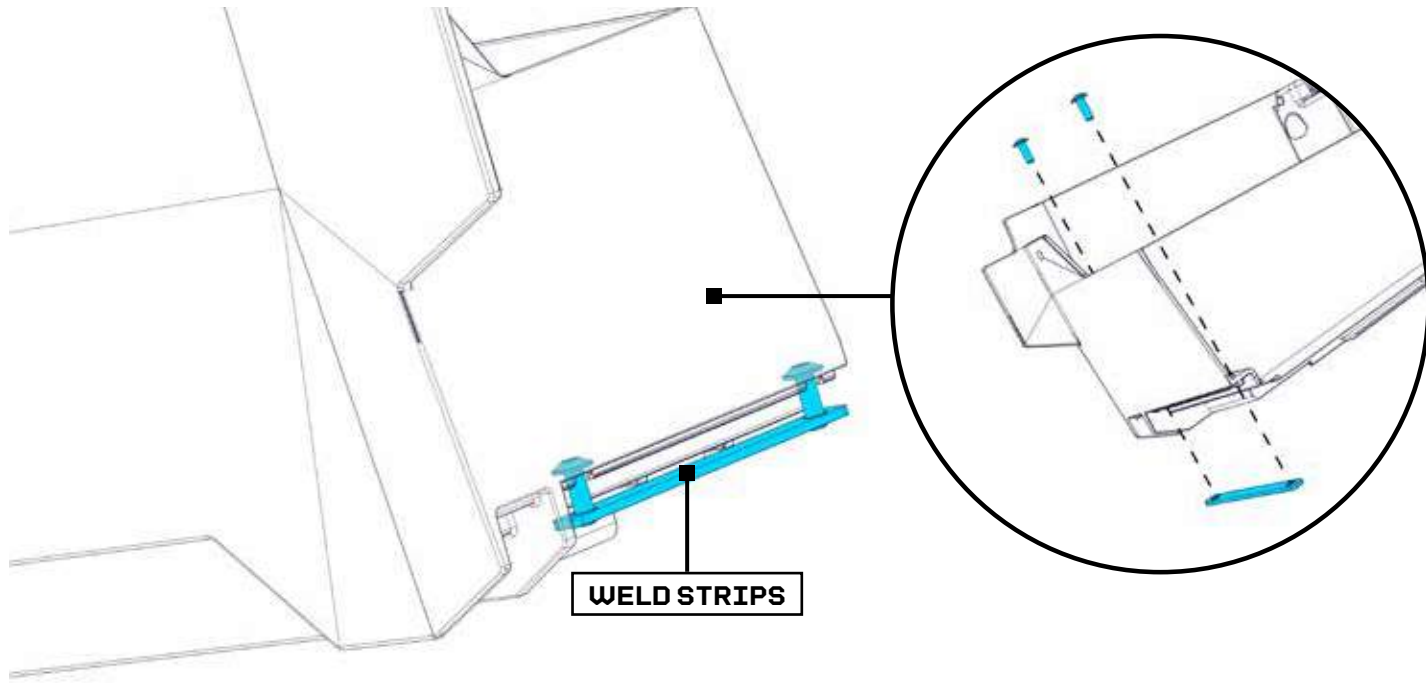

STEP 8:

BUILD THAT DRAWER

1. Make sure to place the assembly with drawer bin and tray on a flat elevated surface (like your truck bed). Do not turn over to screw together and do not rack or allow it to become misaligned.
2. Working from underneath the assembly, use the 3/16" hex key to install the four 1" long screws from the underside of the tray into the bottom of the drawer bin. Tighten until snug.

HARDWARE BAG
MS SCREWS

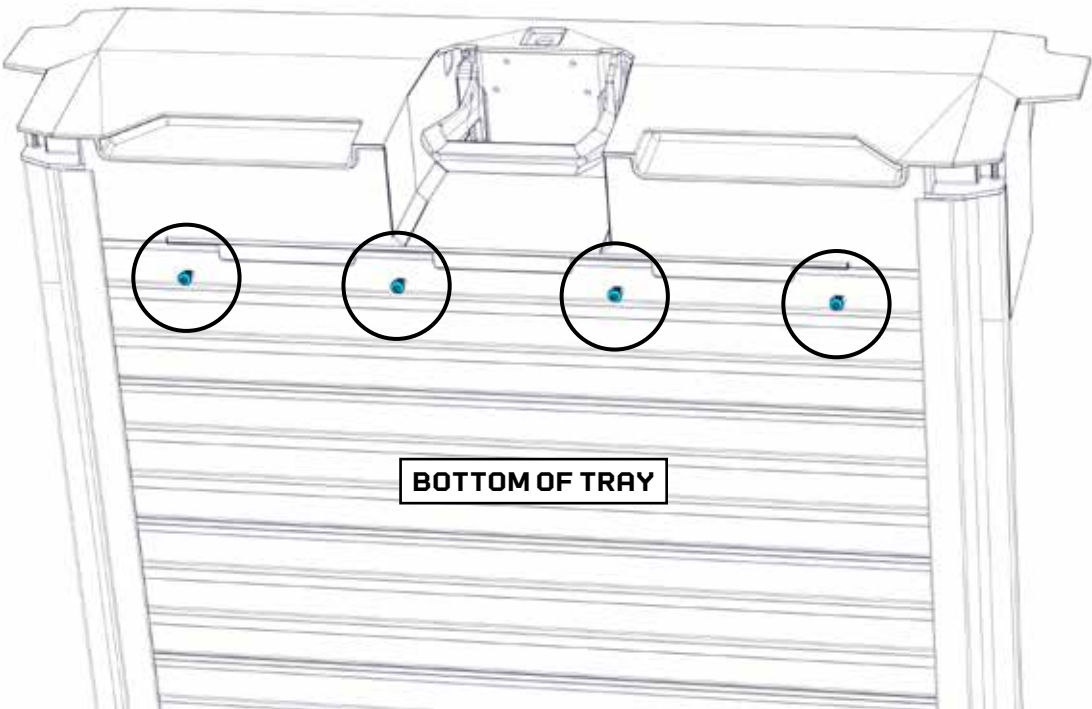
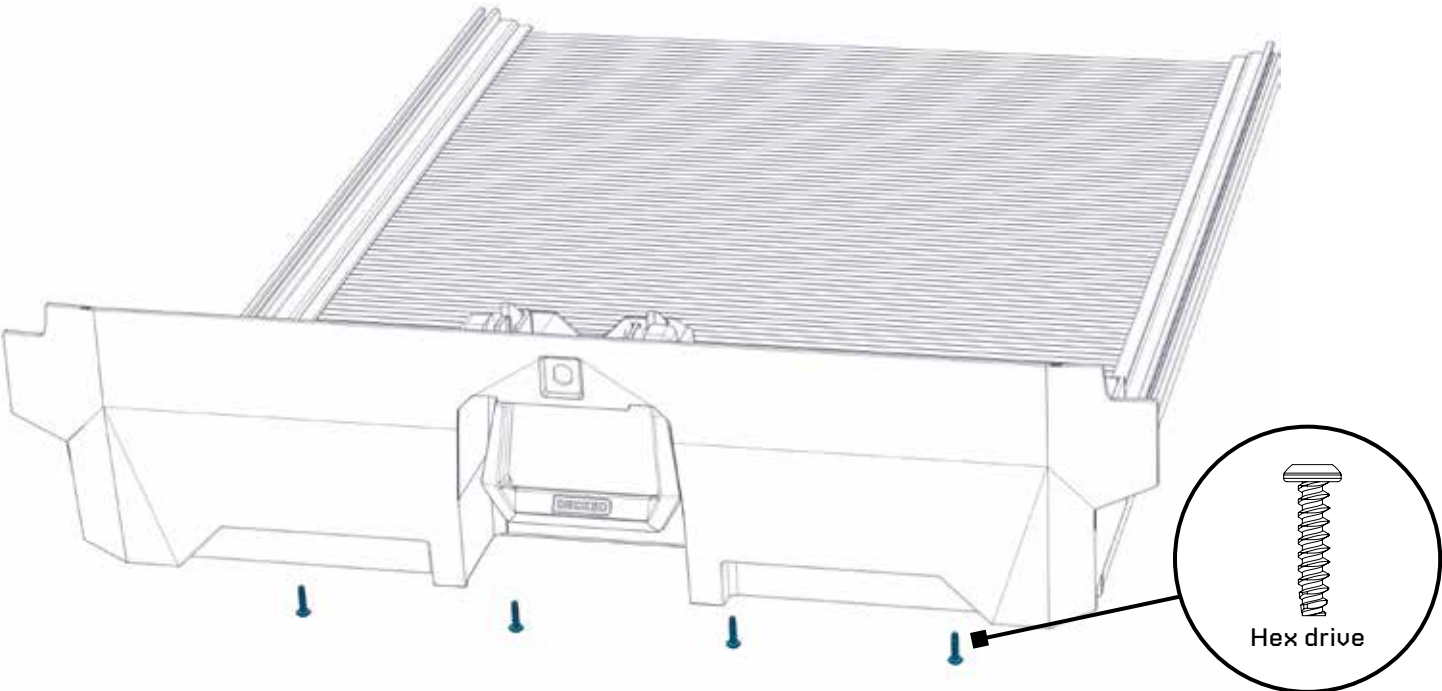

STEP 9:

BUILD THAT DRAWER

1. Insert the ten 1/2" hex head bolts into the channels - five on each side.
2. There are left and right wheel brackets and high sides. Loosely connect the left high side to the left wheel bracket with 1/2" nuts and bolts. The bolt head goes on inside/flange side of the highside and wheel brackets.
3. Install high sides and wheel brackets over the bolts in the channel. The high side flanges should be on the inside of the drawer.
4. Press assembly firmly against drawer bin.
5. Tighten assembly to channel with 10 nuts and bolts.

**HARDWARE BAG
DRAWER BIN HW**

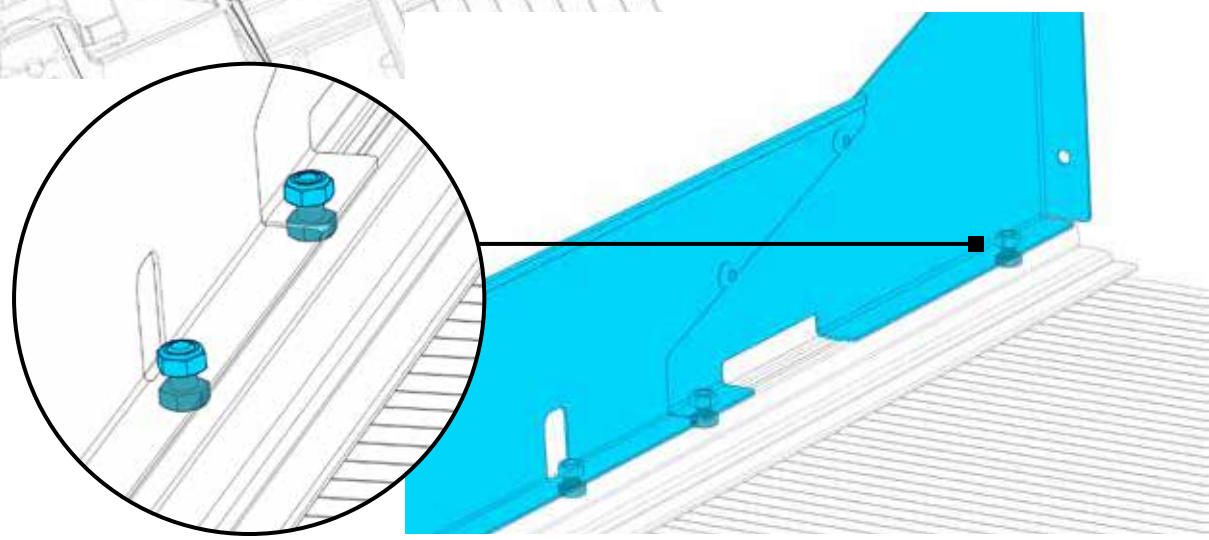
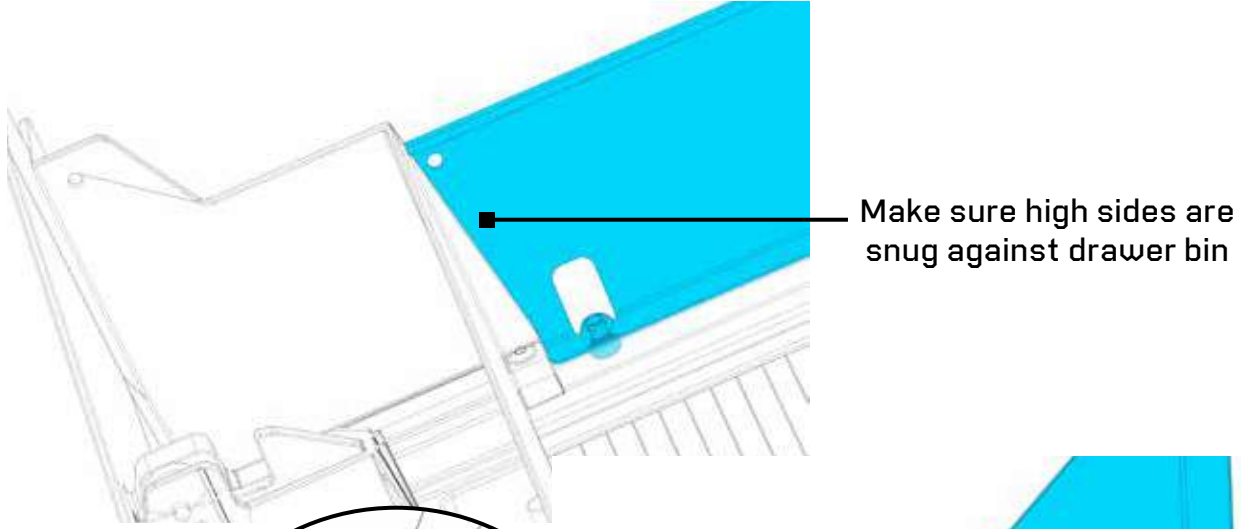
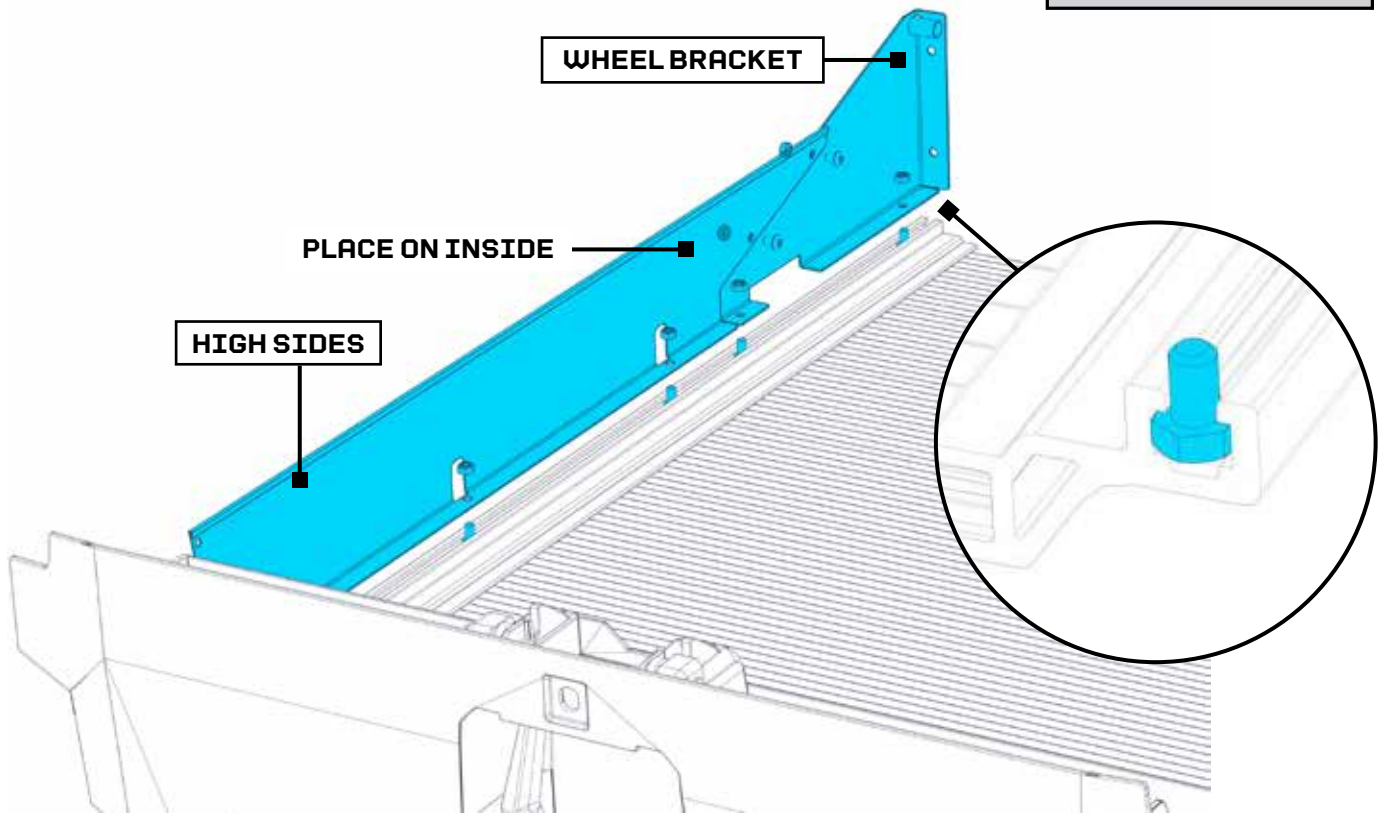

STEP 10:

SECURE THE PERIMETER

1. Tighten high sides to drawer brackets snugly.
2. Slide the back plate onto the assembly.
Rotate up into place.
3. Use 1/2" bolts and nuts to secure the
back plate to the wheel brackets.

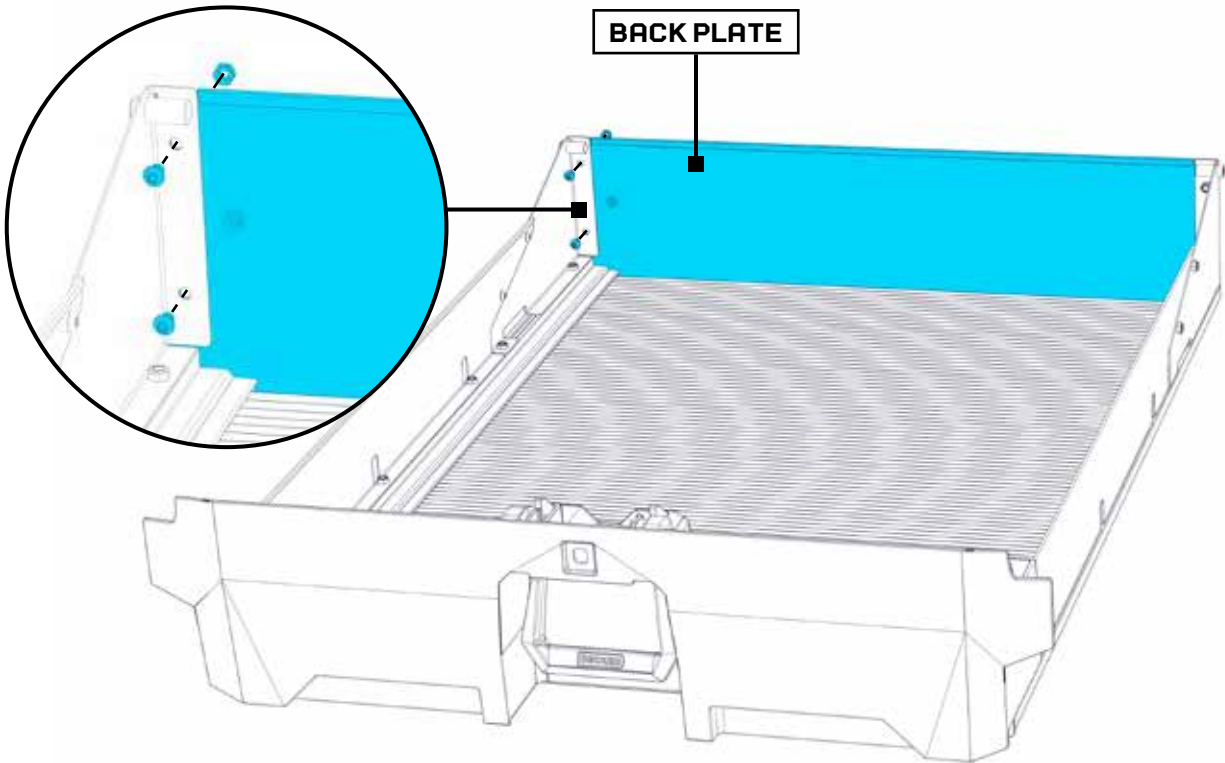
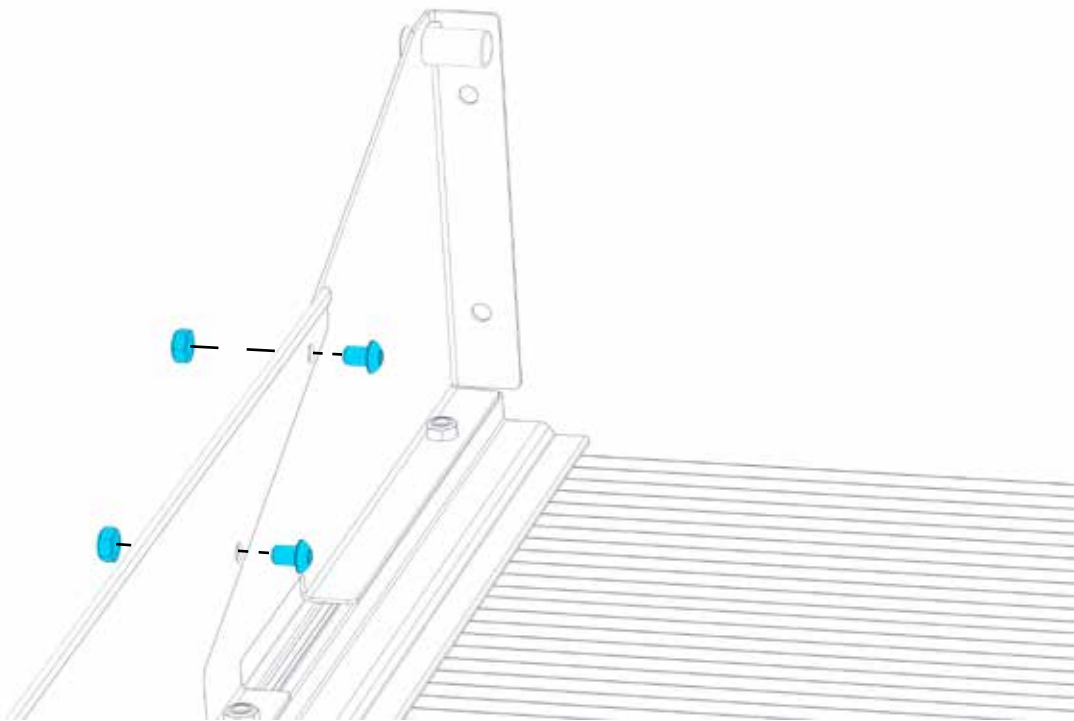

STEP 11:

ONE BIG ASS DRAWER

1. Clip the wheel stops onto the side rails.
They are marked L and R. Don't get this wrong.
2. Install both BIG wheels into the wheel brackets
with a 7/32" hex key.
3. Install the weather strip with the wiper blade
pointing towards the inside of the drawer.
4. Install tray mat.
5. Perform two karate high kicks and a pirouette.

HARDWARE BAG
XY WHEELS, WHEEL STOPS, WEATHERSTRIPS

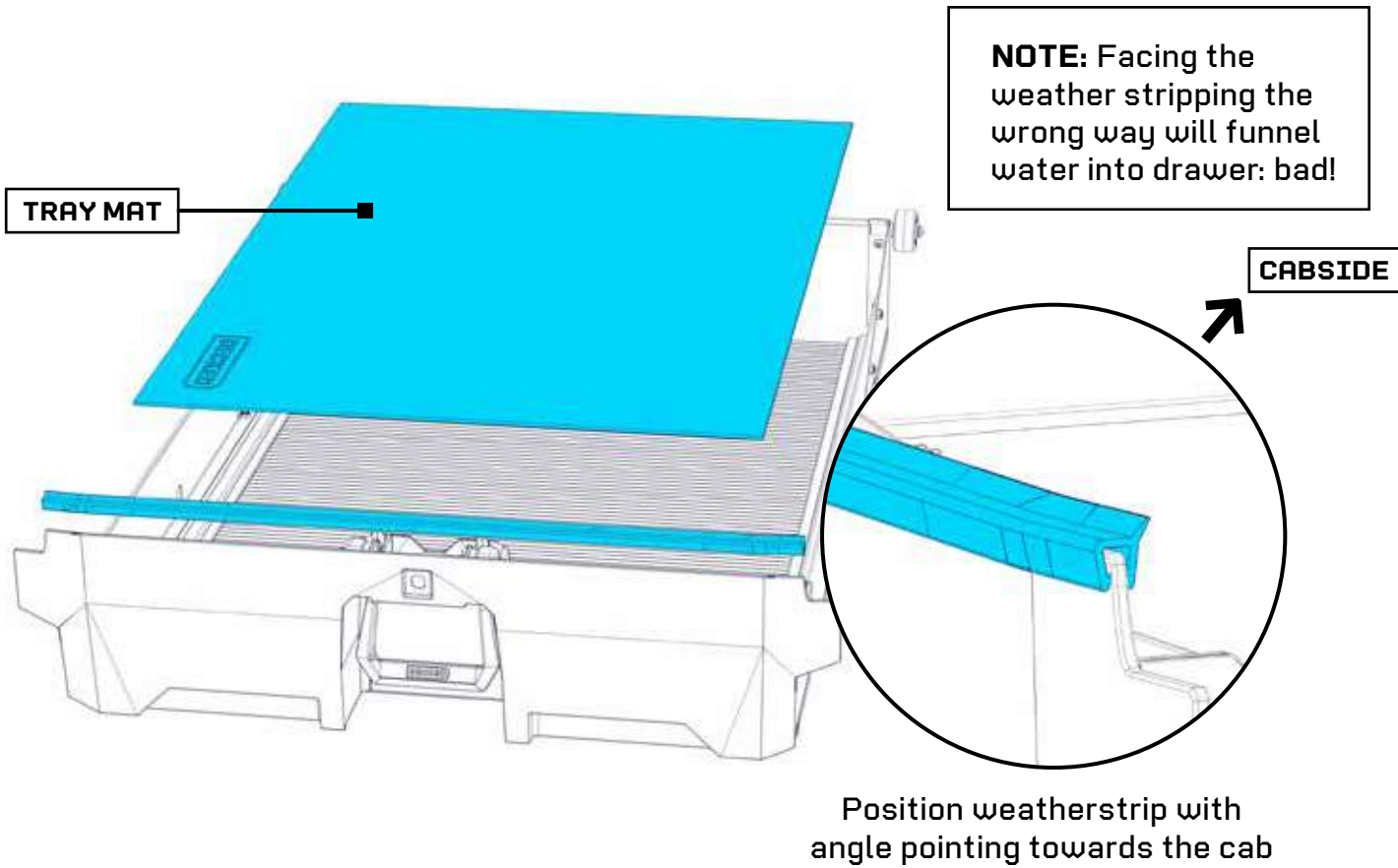
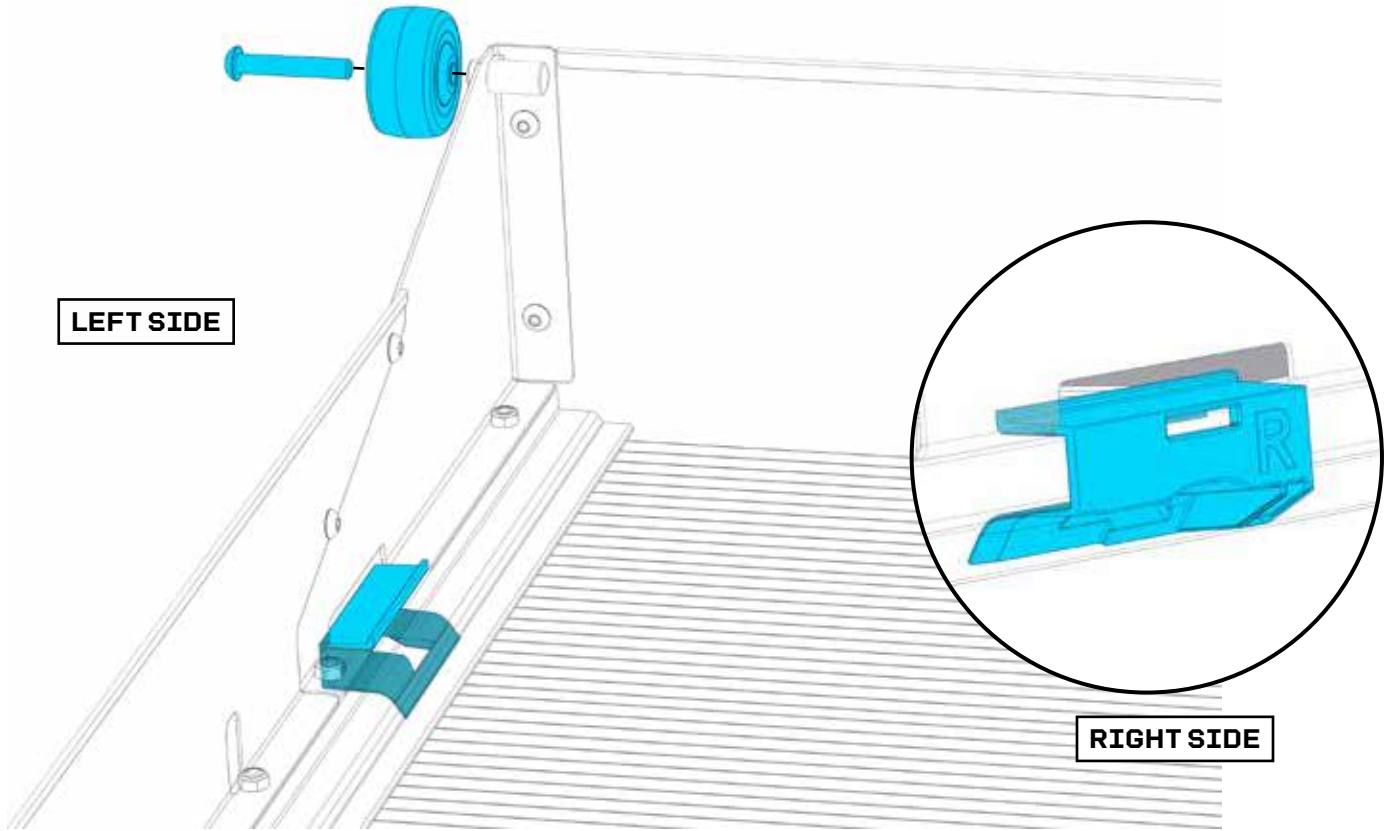

STEP 12:

THAT'S A WRAP

1. Carefully lift the drawer assembly and slide the wheels into the C-Channels.
2. Holding the tailgate side higher, slide the drawer in until the wheel stops clear the tailgate wheels.
3. Level out the drawer and slide all the way in.
4. Install ruler using four 3/16" hex drive screws. Do not over torque, torque boy. Just get 'em snug.
5. Center system and tighten tailgate end turnbuckles like you did earlier.
6. Install the two stash bin lids and two access lids. Install stash bin plugs or locks (if you purchased). Install drawer bin plug or lock.
7. Stand back and say, "YUP" with your hands on your hips.

HARDWARE BAG
MS SCREWS

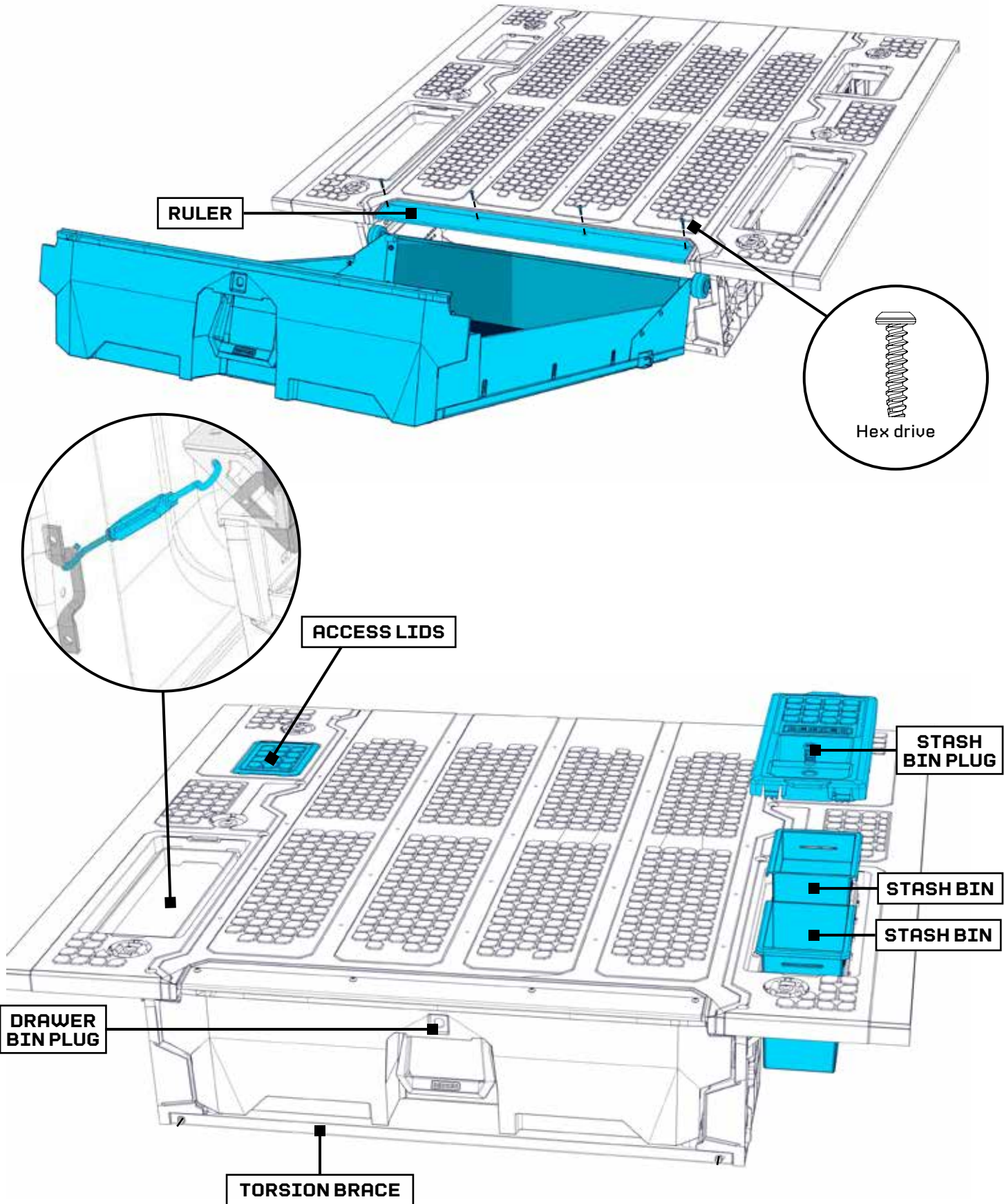

**CONGRATS,
GAME CHANGER!**

YOU DID IT.

Crack open a cold one of your liking, sit back and admire your work. Now get busy organizin'!



DECKED PRODUCTS

LIMITED LIFETIME WARRANTY

(AKA LEGAL MUMBO JUMBO)

(Valid on DECKED Products purchased on or after 8/1/2021)

DECKED LLC, (the "Manufacturer") warrants the original purchaser only that DECKED Truck and Van Products (The "DECKED" Product) will be free from defects in material and workmanship from the date of purchase and continuing for the expected lifetime of the DECKED Product. The DECKED Product must be registered by the original purchaser with DECKED, LLC via its website at, decked.com/register, and a copy of the original sales receipt must be supplied to the Manufacturer at the time a warranty claim is made. This warranty terminates if the original purchaser transfers the DECKED Product to any other person or vehicle.

WHAT IS COVERED

All DECKED Products identified above on or after August 1, 2021. **DECKED's Limited Lifetime Warranty applies to US and Canadian customers only. International shipments are covered by DECKED's 3 Year Limited Warranty.**

WHAT WE WILL DO TO CORRECT PROBLEMS

Subject to the limitations and exclusions described in this limited warranty, the Manufacturer will remedy defects in workmanship or materials by providing one of the following remedies at its option and without charge to the original purchaser for parts: (a) repairing the defective portion of the DECKED Product or (b) replacing the entire DECKED Product. In addition, the Manufacturer may elect at its option not to repair or replace the DECKED Product, but rather issue to the original purchaser a refund equal to the purchase price paid for the DECKED Product or a credit to be used towards the purchase of a new DECKED Product.

WHAT IS NOT COVERED

This limited warranty expressly excludes:

- Damage or defects caused by normal wear and tear, cosmetic rust, scratches, accidents, unlawful vehicle operation, installation in a non-supported vehicle or installed in a vehicle which does not match the DECKED Product's SKU-intended fitment or use, or modification of the product, or any types of repair of a DECKED Product other than those authorized or provided by the Manufacturer.
- Damage or defects resulting from conditions beyond the Manufacturer's control and specifications including, but not limited to modification, misuse, overloading, or failure to assemble, install or use the DECKED Product in accordance with the Manufacturer's written instructions or guidelines included with the DECKED Product or separately made available to the original purchaser.
- Damage to the contents of the DECKED Product or vehicle.
- TO THE EXTENT PERMITTED BY LAW, IN NO EVENT SHALL THE MANUFACTURER BE LIABLE FOR ANY INCIDENTAL, SPECIAL, INDIRECT, OR CONSEQUENTIAL DAMAGES, INCLUDING ECONOMIC LOSS, WHETHER RESULTING FROM NONPERFORMANCE, USE, MISUSE, OR INABILITY TO USE THE DECKED PRODUCT OR THE MANUFACTURER'S NEGLIGENCE.

NO OTHER EXPRESS WARRANTY APPLIES

This Limited Lifetime Warranty is the sole and exclusive warranty for DECKED Products. No employee, agent, dealer, or other person is authorized to alter this warranty or make any other warranty on behalf of DECKED LLC.

NOTIFICATION PROCEDURES

If the DECKED Product does not conform with the terms of this limited warranty, the original purchaser must promptly notify the Manufacturer in writing upon discovery of the nonconformity. In order to receive remedies under this limited warranty, a warranty claim must have been registered with DECKED LLC by the original purchaser, must describe the nature of the products nonconformity, include a copy of the original sales receipt, invoice, or other proof of purchase and be accompanied with photos or video. Repairs or modifications made to the DECKED Product by other than the Manufacturer or its authorized agent will nullify this limited warranty. Coverage under this limited warranty is conditioned at all times upon the owner's compliance with these required registration, notification, and repair procedures.

Product registration may be performed at:
decked.com/register

Warranty claims must include reciprocal contact information and may be made via certified mail or email to:

DECKED Warranty and Claims
PO Box 885
Ketchum, ID 83340
warranty@decked.com
208-806-0251

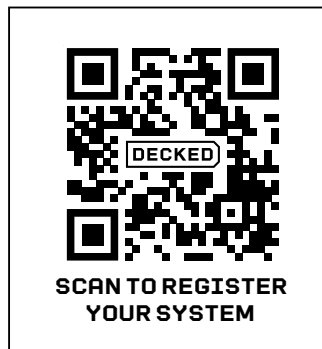

Register your system at
decked.com/warranty

PATENTS

MIDSIZE DRAWER SYSTEM:

US10988087B2, 112017005448.6, AU2017348386A1, 3042037

FULL SIZE DRAWER SYSTEM:

US9527454-B2, USD719905 S, US9168874 B2, CA2969118A1

TOOL BOX:

US20210062581A1

DECKED